



Advanced Laser Technologies

Picosecond Lasers & Laser Systems

Picosecond Lasers

3

Picosecond Tunable Wavelength Lasers

15

Nonlinear Spectroscopy Systems

34



2024

Rev#
240116

About Company

Background

EKSPLA focuses on the design and manufacturing of advanced lasers & systems and employs 30 years' experience as well as a close partnership with the scientific community. 80 out of the 100 top universities use EKSPLA lasers. The company is leading in the global market for scientific picosecond lasers.

Clients like CERN, NASA, ELI, Max Planck Institutes, Cambridge University and Massachusetts Institute of Technology have chosen Ekspla as their partner.

For scientist who needs unique instrument for research, we provide parameter tailored laser systems that enable customer to perform complex experiments. In-house design and manufacturing ensures operative design, manufacturing and customization of new products.

Highly stable and reliable EKSPLA lasers combined with our own subsidiaries in the US, UK and China as well as more than 20 approved representative offices with properly trained laser engineers worldwide, ensure short response time and fast laser service as well as maintenance.



History

EKSPLA was founded about 30 years ago by a small team of engineers united around the idea of making the most advanced lasers in the world. EKSPLA was independent company with little money, but lots of creativity, and a deep technical understanding of lasers and how useful they could be for research and industry. From the start, the whole team had a deep mutual respect and believed in and supported each other. The first laser was sold at its first launch event, at an international exhibition in Germany. Soon after, the innovation was noticed by partners in Japan, and supply of the systems to leading universities there has been started. The concept of continuous improvement was admired and embraced, so it has become one of the key principles that apply to everything is done.

Contents

Picosecond Lasers	3
PL2210 series	
Diode Pumped Picosecond kHz Pulsed Nd:YAG Lasers	4
PL2230 series	
Diode Pumped High Energy Picosecond Nd:YAG Lasers	7
PL2250 series	
Flash-Lamp Pumped Picosecond Nd:YAG Lasers	11
Picosecond Tunable Wavelength Lasers	15
PGx01 series	
High Energy Broadly Tunable OPA	16
PGx11 series	
Transform Limited Broadly Tunable Picosecond OPA	20
PT277-XIR series	
Single Housing MIR Tunable Picosecond Laser	25
PT277 series	
Single Housing NIR-IR Range Tunable Picosecond Laser	27
PT403 series	
Tunable Wavelength Picosecond Laser	29
Nonlinear Spectroscopy Systems	34
SFG spectrometer	
Picosecond Vibrational Sum Frequency Generation Spectrometer	35
Ordering Information	42

Picosecond Lasers

The first EKSPILA picosecond laser has been sold on its first launch event in exhibition in Germany more than 30 years ago. Due to their excellent stability and high output parameters EKSPILA scientific picosecond lasers established their name as "Gold Standard" among scientific picosecond lasers.

Innovative design of new generation of picosecond mode-locked lasers feature diode-pumping-only technology, thus reducing maintenance costs and improving output parameters.

Second, third, fourth and fifth (on some versions) harmonic options combined with various accessories, advanced electronics (for streak camera synchronization, phase-locked loop, synchronization of fs laser) and customization possibilities make these lasers well suited for many scientific applications, including optical parametric generator pumping, time-resolved spectroscopy, nonlinear spectroscopy, remote sensing, metrology...

For customer convenience the laser can be operated from master device or personal computer through USB (VCP, ASCII commands), RS232 (ASCII commands), LAN (REST API) or RS232 (ASCII commands), LAN (REST API) depending on the system configuration or from remote control pad with backlit display that is easy to read even while wearing laser safety glasses.

SHORT SELECTION GUIDE

For Your convenience, table contains all available options and highest parameter values. Not all output specifications are available at the same time simultaneously. Please refer to the catalog page for exact specifications and available options.

Model	Max pulse energy at fundamental wavelength	Repetition rate, up to	Pumping	Pulse duration	Special feature	Page
PL2210	5 mJ at 1064 nm	1000 Hz	Diode pumped solid state	29 ± 5 ps	kHz repetition rate	4
PL2230	40 mJ at 1064 nm	100 Hz	Diode pumped solid state	29 ± 5 ps	High pulse energy employing DPSS only technology	7
PL2250	100 mJ	20 Hz	Hybrid (DPSS master oscillator and flash-lamp pumped power amplifier)	29 ± 5 ps	High pulse energy	11

PL2210 SERIES



PL2210 series diode-pumped, air-cooled, mode-locked Nd:YAG lasers provide picosecond pulses at a kilohertz pulse repetition rate.

Short pulse duration, excellent pulse-to-pulse stability, superior beam quality makes PL2210 series diode pumped picosecond lasers well suited for many applications, including material processing, time-resolved spectroscopy, optical parametric generator pumping, and other tasks.

Flexible design

PL2210 series lasers offer a number of optional items that extend the capabilities of the laser. A pulse picker option allows control of the pulse repetition rate of the laser and operation in single-shot mode.

The repetition rate and timing of pulses can be locked to an external RF source (with –PLL option) or other ultrafast laser system (with –FS option). The laser provides a triggering pulse for synchronization of the customer’s equipment. A low jitter SYNC OUT pulse has a lead up to 500 ns that can be adjusted in ~0.25 ns steps from a PC. Up to 400 μs lead of triggering pulse is available as a PRETRIG feature that is designed to provide precise, very low jitter trigger pulses for a streak camera.

Built-in harmonic generators

Motorised switching of wavelength for PL2210A. Non-linear crystals mounted in temperature stabilized heaters are used for second, third and fourth high spectral purity harmonic generation.

Available models ¹⁾

Model	Features
PL2210A-1k	Up to 900 μJ, 29 ps pulses at an up to 1 kHz repetition rate
PL2211A	Up to 5 mJ energy at a 1 kHz repetition rate at 28 ps pulses

¹⁾ Custom-built models with higher pulse energy are available on request.

Diode Pumped Picosecond kHz Pulsed Nd:YAG Lasers

FEATURES

- ▶ High pulse energy at kHz rates
- ▶ Diode pumped **solid state** design
- ▶ **Air cooled** – external water supply is not required (for PL2210A-1k only)
- ▶ Turn-key operation
- ▶ Low maintenance costs
- ▶ Optional streak camera triggering pulse with <10 ps rms jitter
- ▶ Remote control pad
- ▶ PC control
- ▶ Optional temperature stabilized second, third and fourth **harmonic generators**

APPLICATIONS

- ▶ Time resolved fluorescence (including streak camera measurements), pump-probe spectroscopy
- ▶ OPG/OPA/OPO pumping
- ▶ Remote Laser Sensing
- ▶ Other spectroscopic and nonlinear optics applications

Simple and convenient laser control

For customer convenience the laser can be operated from master device or personal computer through USB (VCP, ASCII commands), RS232 (ASCII commands), LAN (REST API) or RS232 (ASCII commands), LAN (REST API) depending on the system configuration or from remote control pad with backlit display that is easy to read even while wearing laser safety glasses.

SPECIFICATIONS ¹⁾

Model	PL2210A	PL2211A
Output energy		
at 1064 nm	0.9 mJ	5 mJ
at 532 nm ²⁾	0.45 mJ	2.5 mJ
at 355 nm ³⁾	0.35 mJ	1.6 mJ
at 266 nm ⁴⁾	0.16 mJ	1 mJ
Pulse energy stability (StdDev) ⁵⁾		
at 1064 nm	0.5 %	
at 532 nm	0.8 %	
at 355 nm	1 %	
at 266 nm	2 %	
Pulse duration (FWHM) ⁶⁾	29 ± 5 ps	
Pulse repetition rate	1 kHz	
Triggering mode	internal/external	
Typical TRIG1 OUT pulse delay ⁸⁾	-500 ... 50 ns	
TRIG1 OUT pulse jitter	< 0.1 ns rms	
Spatial mode ⁹⁾	Close to Gaussian	
Beam divergence ¹⁰⁾	<1 mrad	
Beam diameter ¹¹⁾	1.7 ± 0.3 mm	~3 mm
Beam pointing stability (RMS) ¹²⁾	< 30 µrad	
Pre-pulse contrast	> 200 : 1	
Polarization	linear, >100 : 1	
PHYSICAL CHARACTERISTICS		
Laser head size (W × L × H) ¹³⁾	456 × 1031 × 249 mm	
Power supply size (W × L × H)	365 × 392 × 290 mm	550 × 600 × 550 ±3 mm (19" standard, MR-9)
OPERATING REQUIREMENTS		
Water service	not required, air cooled	
Relative humidity	20–80 % (non condensing)	
Ambient temperature	22 ± 2 °C	
Power requirements	100–240 V AC, single phase 50/60 Hz	
Power consumption ¹⁴⁾	<1 kW	<1.5 kW

¹⁾ Due to continuous improvement, all specifications are subject to change without notice. Parameters marked typical are not specifications. They are indications of typical performance and will vary with each unit we manufacture. Unless stated otherwise, all specifications are measured at 1064 nm and for basic system without options.

²⁾ For PL2210 series laser with -SH, -SH/TH, -SH/FH or -SH/TH/FH option. Outputs are not simultaneous.

³⁾ For PL2210 series laser with -TH, -SH/TH or -SH/TH/FH option. Outputs are not simultaneous.

⁴⁾ For PL2210 series laser with -SH/FH or -SH/TH/FH option. Outputs are not simultaneous.

⁵⁾ Averaged from pulses, emitted during 30 sec time interval.

⁶⁾ Optional 80 or 22 ps ± 10% duration. Pulse energy specifications may differ from indicated here.

⁷⁾ With respect to optical pulse. <10 ps rms jitter is provided optionally with PRETRIG feature.

⁸⁾ TRIG1 OUT lead or delay can be adjusted with 0.25 ns steps in specified range.

⁹⁾ Near field Gaussian fit is >90%.

¹⁰⁾ Average of X- and Y-plane full angle divergence values measured at the 1/e² level at 1064 nm.

¹¹⁾ Beam diameter is measured at 1064 nm at the 1/e² point.

¹²⁾ Beam pointing stability is evaluated from fluctuations of beam centroid position in the far field.

¹³⁾ 456×1233×249 mm (W×L×H) laser head size might be required for some optional configurations.

¹⁴⁾ At 1 kHz pulse repetition rate.



OPTIONS

- ▶ **PRETRIG** provides low jitter pulse for streak camera triggering with lead/delay in -400...600 μ s range and <10 ps rms jitter.
- ▶ **Option P80** provides 80 ps \pm 10 % output pulse duration. Inquire for pulse energy specifications.
- ▶ **Option P20** provides 22 ps \pm 10 % output pulse duration. Inquire for pulse energy specifications.
- ▶ **Option PC** allows reduction of the pulse repetition rate of the PL2210 series laser by integer numbers. Single shot mode is also possible. In addition, the -PC option reduces the low-intensity quasi-CW background that is present at laser output at 1064 nm wavelength. Please note that the output of fundamental wavelength and harmonic will be reduced by approx. 20% with installation of the -PC option.

BEAM PROFILE

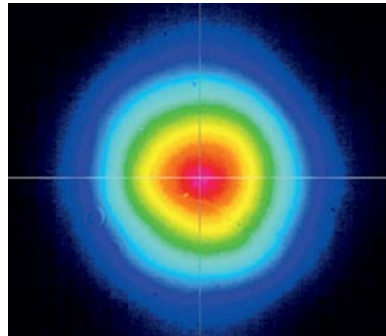

Fig 1. Typical PL2210 series laser near field beam profile at 1064 nm except PL2211A

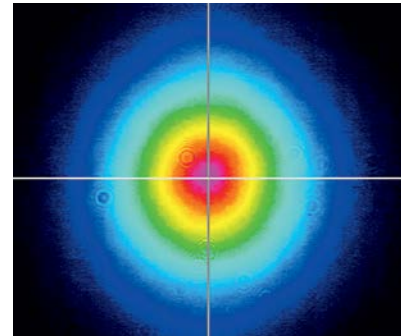

Fig 2. Typical PL2211A laser near field beam profile at 1064 nm

OUTLINE DRAWINGS

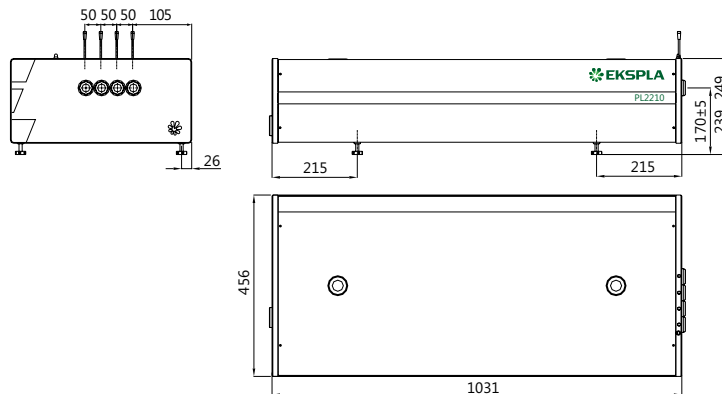

Fig 3. Dimensions of PL2210 series laser head

ORDERING INFORMATION

Note: Laser must be connected to the mains electricity all the time. If there will be no mains electricity for longer than 1 hour then laser (system) needs warm up for a few hours before switching on.

PL2210A-SH/TH/FH-P20

Model	
Harmonic generator options:	
SH	→ second harmonic
TH	→ third harmonic
FH	→ fourth harmonic
Other options:	
P80	→ 80 ps pulse duration option
P20	→ 20 ps pulse duration option
PC	→ pulse picker option
PLL	→ pulse repetition rate locking option

PL2230 SERIES



Innovative design

The heart of the system is a diode pumped solid state (DPSS) master oscillator placed in a sealed monolithic block, producing high repetition rate pulse trains (87 MHz) with a low single pulse energy of several nJ. Diode pumped amplifiers are used for amplification of the pulse to 30 mJ or up to 40 mJ output. The high-gain regenerative amplifier has an amplification factor in the proximity of 10^6 . After the regenerative amplifier, the pulse is directed to a multipass power amplifier that is optimized for efficient stored energy extraction from the Nd:YAG rod, while maintaining a near Gaussian beam profile and low wavefront distortion. The output pulse energy can be adjusted in approximately 1% steps, while pulse-to-pulse energy stability remains at less than 0.5% rms at 1064 nm.

Angle-tuned KD*P and KDP crystals mounted in thermostabilised ovens are used for second, third, and fourth harmonic generation. Harmonic separators ensure the high spectral purity of each harmonic guided to different output ports.

Built-in energy monitors continuously monitor output pulse energy. Data from the energy monitor can be seen on the remote keypad or on a PC monitor. The laser provides triggering pulses for the synchronisation of your equipment. The lead of the triggering pulse can be up to 500 ns and is user adjustable in ~ 0.25 ns steps from a personal computer. Up to 1000 μ s lead of triggering pulse is available as a pretrigger feature. Precise pulse energy control, excellent short-term and long-term stability, and a 50 Hz repetition rate makes PL2230 series lasers an excellent choice for many demanding scientific applications.

Simple and convenient laser control

For customer convenience the laser can be operated from master device or personal computer through USB (VCP, ASCII commands), RS232 (ASCII commands), LAN (REST API) or RS232 (ASCII commands), LAN (REST API) depending on the system configuration or from remote control pad with backlit display that is easy to read even while wearing laser safety glasses.

Diode Pumped High Energy Picosecond Nd:YAG Lasers

FEATURES

- ▶ Diode pumped power amplifier producing up to **40 mJ** per pulse at 1064 nm
- ▶ Beam profile improvement using advanced beam shaping system
- ▶ Hermetically sealed DPSS master oscillator
- ▶ Diode pumped regenerative amplifier
- ▶ Air-cooled
- ▶ **<30 ps** pulse duration
- ▶ Excellent pulse duration stability
- ▶ Up to **100 Hz** repetition rate
- ▶ Streak camera triggering pulse with **<10 ps** jitter
- ▶ Excellent beam pointing stability
- ▶ Thermo stabilized second, third or fourth harmonic generator options
- ▶ PC control
- ▶ Remote control via keypad

APPLICATIONS

- ▶ Time resolved fluorescence (including streak camera measurements)
- ▶ SFG/SHG spectroscopy
- ▶ Nonlinear spectroscopy
- ▶ Laser-induced breakdown spectroscopy
- ▶ OPG pumping
- ▶ Remote laser sensing
- ▶ Satellite ranging
- ▶ Other spectroscopic and nonlinear optics applications

SPECIFICATIONS ¹⁾

Model	PL2230-100	PL2231-100	PL2231-50	PL2231A-50
Pulse energy ²⁾				
at 1064 nm	3 mJ	12 mJ	30 mJ	40 mJ
at 532 nm ³⁾	1.3 mJ	5 mJ	13 mJ	18 mJ
at 355 nm ⁴⁾	0.9 mJ	3.5 mJ	9 mJ	13 mJ
at 266 nm ⁵⁾	0.3 mJ	1.2 mJ	3 mJ	5 mJ
at 213 nm ⁶⁾	inquire			
Pulse energy stability (StdDev) ⁷⁾				
at 1064 nm	< 0.2 %		< 0.5 %	
at 532 nm	< 0.4 %		< 0.8 %	
at 355 nm	< 0.5 %		< 1.1 %	
at 266 nm	< 0.5 %		< 1.2 %	
at 213 nm	< 1.5 %		< 1.5 %	
Pulse duration (FWHM) ⁸⁾	29 ± 5 ps			
Pulse duration stability ⁹⁾	± 1 %			
Power drift ¹⁰⁾	± 2 %			
Pulse repetition rate				
At 1064, 532, 355 nm	0 – 100 Hz	100 Hz	50 Hz	50 Hz
At 266, 213 nm	0 – 100 Hz		10 Hz	
Polarization	vertical, >99 % at 1064 nm			
Pre-pulse contrast	> 200 : 1 (peak-to-peak with respect to residual pulses)			
Beam profile ¹¹⁾	close to Gaussian in near and far fields			
Beam divergence ¹²⁾	< 1.5 mrad		< 0.7 mrad	
Beam propagation ratio M ²	< 1.3		< 2.5	
Beam pointing stability (RMS) ¹³⁾	≤ 10 μrad		≤ 20 μrad	
Typical beam diameter ¹⁴⁾	~ 2 mm		~ 6 mm	~ 7 mm
Optical pulse jitter				
Internal triggering regime ¹⁵⁾	<50 ps (StdDev) with respect to TRIG1 OUT pulse			
External triggering regime ¹⁶⁾	~3 ns (StdDev) with respect to SYNC IN pulse			
TRIG1 OUT pulse delay ¹⁷⁾	-500 ... 50 ns			
Typical warm-up time	5 min		15 min	
PHYSICAL CHARACTERISTICS				
Laser head size (W × L × H)	456×1031×249 ± 3 mm			
Electrical cabinet size (W × L × H)	12 V DC power adapter, 85×170×41 ± 3 mm	471×391×147 ± 3 mm		
Umbilical length	2.5 m			
OPERATING REQUIREMENTS				
Cooling ¹⁸⁾	stand-alone chiller			
Room temperature	22±2 °C			
Relative humidity	20 – 80 % (non-condensing)			
Power requirements	110–240 V AC, 50/60 Hz	Single phase, 110–240 V AC, 5 A, 50/60 Hz		
Power consumption	< 0.15 kVA	< 1.0 kVA		

¹⁾ Due to continuous improvement, all specifications are subject to change without notice. Parameters marked typical are not specifications. They are indications of typical performance and will vary with each unit we manufacture. Unless stated otherwise, all specifications are measured at 1064 nm and for basic system without options.

²⁾ Outputs are not simultaneous.

³⁾ For PL2230 series laser with -SH, -SH/TH, -SH/FH or -SH/TH/FH option or -SH/TH/FH/FiH module.

⁴⁾ For PL2230 series laser with -TH, -SH/TH or -SH/TH/FH option or -SH/TH/FH/FiH module.

⁵⁾ For PL2230 series laser with -SH/FH or -SH/TH/FH option or -SH/TH/FH/FiH module.

⁶⁾ For PL2230 series laser with -SH/TH/FH/FiH module.

⁷⁾ Averaged from pulses, emitted during 30 sec time interval.

⁸⁾ FWHM. Inquire for optional pulse durations in 20 – 90 ps range. Pulse energy specifications may differ from indicated here.

⁹⁾ Measured over 1 hour period when ambient temperature variation is less than ±1 °C.

¹⁰⁾ Measured over 8 hours period after 20 min warm-up when ambient temperature variation is less than ± 2 °C.

¹¹⁾ Near field Gaussian fit is >80%.

¹²⁾ Average of X- and Y-plane full angle divergence values measured at the 1/e² level at 1064 nm.

¹³⁾ Beam pointing stability is evaluated from fluctuations of beam centroid position in the far field.

¹⁴⁾ Beam diameter is measured at 1064 nm at the 1/e² level.

¹⁵⁾ With respect to TRIG1 OUT pulse. <10 ps jitter is provided optionally with PRETRIG feature.

¹⁶⁾ With respect to SYNC IN pulse.

¹⁷⁾ TRIG1 OUT lead or delay can be adjusted with 0.25 ns steps in specified range.

¹⁸⁾ Air cooled. Adequate room air conditioning should be provided.



OPTIONS

- **Option P20** provides 20 ps ±10% output pulse duration. Pulse energies are ~ 30 % lower in comparison to the 28 ps pulse duration version. See table below for pulse energy specifications:

Model	PL2231-50	PL2231A-50
1064 nm	23 mJ	28 mJ
532 nm	9 mJ	13 mJ
355 nm	6 mJ	9 mJ
266 nm	2 mJ	4 mJ

- **Option P80** provides 80 ps ± 10% output pulse duration. Pulse energy specifications are same as those of 28 ps lasers.
- **Option PLL** allows locking the master oscillator pulse train repetition rate to an external RF generator, enabling precise external triggering with low jitter. Inquire for more information.

- **Option PL2231A-50 HE**

Pulse repetition rate 50 Hz. The pulse energy is ~30% higher compared to the laser without depolarization compensation. 29±5 ps output pulse duration. See table below for pulse energy specifications:

Model ^{1) 2)}	PL2231A-50 HE
1064 nm	50 mJ

- **Option PL2231A-10**

Pulse repetition rate 10 Hz. The pulse energy is ~2 times higher compared to the 50 Hz laser version. 29±5 ps output pulse duration. See table below for pulse energy specifications:

Model ^{1) 2)}	PL2231A-10
1064 nm	80 mJ
532 nm ³⁾	50 mJ
355 nm	inquire
216 nm	inquire
213 nm	inquire

¹⁾ Due to continuous improvement, all specifications are subject to change without notice. Parameters marked typical are not specifications. They are indications of typical performance and will vary with each unit we manufacture. Unless stated otherwise, all specifications are measured at 1064 nm and for basic system without options. Specifications for model PL2231C are preliminary and should be confirmed against quotation and purchase order.
²⁾ Outputs are not simultaneous.
³⁾ For PL2231A-10 series laser with -SH module.

BEAM PROFILE

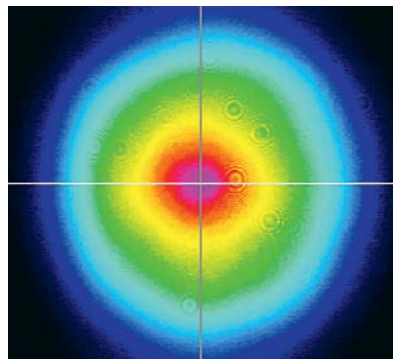

Fig 1. Typical near field output beam profile of PL2230 model laser

OUTLINE DRAWINGS

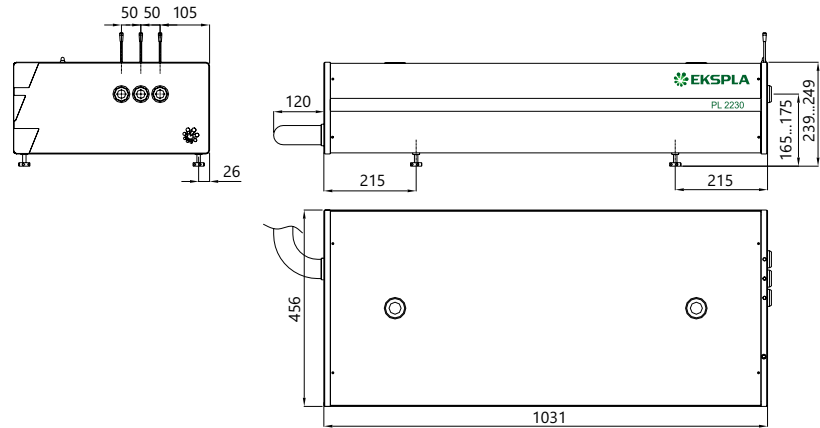
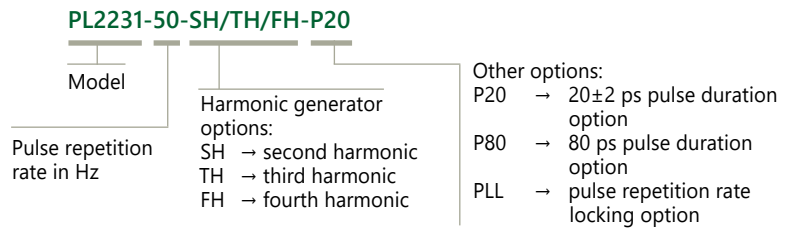

Fig 2. Dimensions of PL2230 series laser head

ORDERING INFORMATION

Note: Laser must be connected to the mains electricity all the time. If there will be no mains electricity for longer than 1 hour then laser (system) needs warm up for a few hours before switching on.



PL2250 SERIES



PL2250 series lasers cost-effective design improves laser reliability and reduces running and maintenance costs.

Innovative design

The heart of the system is a diode pumped solid state (DPSS) master oscillator placed in a hermetically sealed monolithic block. The flashlamp pumped regenerative amplifier is replaced by an innovative diode pumped regenerative amplifier. Diode pumping results in negligible thermal lensing, which allows operation of the regenerative amplifier at variable repetition rates, as well as improved long-term stability and maintenance-free operation.

The optimized multiple-pass power amplifier is flashlamp pumped and is optimized for efficient amplification of pulse while maintaining a near Gaussian beam profile and low wavefront distortion. The output pulse energy can be adjusted in approximately 1% steps, at the same time as pulse-to-pulse energy stability remains less than 0.8% rms at 1064 nm.

Angle-tuned KD*P and KDP crystals mounted in thermostabilised ovens are used for second, third and fourth harmonic generation. Harmonic

separators ensure the high spectral purity of each harmonic directed to different output ports.

Built-in energy monitors continuously monitor output pulse energy. Data from the energy monitor can be seen on the remote keypad or PC monitor. The laser provides several triggering pulses for synchronization of the customer's equipment. The lead or delay of the triggering pulse can be adjusted in 0.25 ns steps from the control pad or PC. Up to 1000 μ s lead of triggering pulse is available as a pretrigger feature.

Precise pulse energy control, excellent short-term and long-term stability, and up to 20 Hz repetition rate makes PL2250 series lasers an excellent choice for many demanding scientific applications.

Simple and convenient laser control

For customer convenience the laser can be operated from master device or personal computer through USB (VCP, ASCII commands), RS232 (ASCII commands), LAN (REST API) or RS232 (ASCII commands), LAN (REST API) depending on the system configuration or from remote control pad with backlit display that is easy to read even while wearing laser safety glasses.

Flash-Lamp Pumped Picosecond Nd:YAG Lasers

FEATURES

- ▶ Hermetically sealed DPSS master oscillator
- ▶ Diode pumped regenerative amplifier
- ▶ Flashlamp pumped power amplifier producing up to **100 mJ** per pulse at 1064 nm
- ▶ **30 ps** pulse duration (20 ps optional)
- ▶ Excellent pulse duration stability
- ▶ Up to **20 Hz** repetition rate
- ▶ Streak camera triggering pulse with <10 ps jitter
- ▶ Excellent beam pointing stability
- ▶ Thermo-stabilized second, third, fourth and fifth harmonic generator options
- ▶ PC control
- ▶ Remote control via keypad

APPLICATIONS

- ▶ Time resolved fluorescence (including streak camera measurements)
- ▶ SFG/SHG spectroscopy
- ▶ Nonlinear spectroscopy
- ▶ Laser-induced breakdown spectroscopy
- ▶ OPG pumping
- ▶ Remote laser sensing
- ▶ Satellite ranging
- ▶ Other spectroscopic and nonlinear optics experiments

SPECIFICATIONS ¹⁾

Model	PL2251A	PL2251B	PL2251C
Pulse energy			
at 1064 nm	50 mJ ²⁾	80 mJ ²⁾	100 mJ
at 532 nm ³⁾	25 mJ	40 mJ	50 mJ
at 355 nm ⁴⁾	15 mJ	24 mJ	30 mJ
at 266 nm ⁵⁾	7 mJ	10 mJ	12 mJ
at 213 nm ⁶⁾		inquire	
Pulse energy stability, (StdDev.) ⁷⁾			
at 1064 nm		< 0.8 %	
at 532 nm		<1.0 %	
at 355 nm		< 1.1 %	
at 266 nm		< 1.2 %	
Pulse duration (FWHM) ⁸⁾			
		29 ± 5 ps	
Pulse duration stability ⁹⁾			
		± 1.0 ps	
Repetition rate			
	20 or 10 Hz		10 Hz
Polarization			
	linear, vertical, >99 %		
Pre-pulse contrast			
	>200:1 (peak-to-peak with respect to residual pulses)		
Optical pulse jitter			
	internal / external		
Internal triggering regime ¹⁰⁾			
	<50 ps (StdDev) with respect to TRIG1 OUT pulse		
External triggering regime ¹¹⁾			
	~3 ns (StdDev) with respect to SYNC IN pulse		
SYNC OUT pulse delay ¹²⁾			
	-500 ... 50 ns		
Beam divergence ¹³⁾			
	< 0.5 mrad		
Beam pointing stability (RMS) ¹⁴⁾			
	≤ 20 μrad		
Beam diameter ¹⁵⁾			
	~ 8 mm	~10 mm	~12 mm
Typical warm-up time			
	30 min		

PHYSICAL CHARACTERISTICS

Laser head size (W × L × H)	456×1233×249 mm ±3 mm (for PL2251A, B with harmonic and C models) 456×1031×249 mm ±3 mm (for PL2251A, B models without harmonic)		
Electric cabinet size (W × L × H)	550×600×550 ±3 mm (19" standard, MR-9)		
Umbilical length	2.5 m		

OPERATING REQUIREMENTS

Water consumption (max 20 °C)	water cooled, water consumption (max. 20 °C), <8 l/min, 2 bar		
Room temperature	22 ± 2 °C		
Relative humidity	20–80 % (non-condensing)		
Power requirements ¹⁶⁾	single phase, 200–240 V AC, 16 A, 50/60 Hz		
Power ¹⁷⁾	< 1.5 kVA	< 2.5 kVA	< 2.5 kVA

¹⁾ Due to continuous improvement, all specifications are subject to change without notice. Parameters marked typical are not specifications. They are indications of typical performance and will vary with each unit we manufacture. Unless stated otherwise, all specifications are measured at 1064 nm and for basic system without options.
²⁾ PL2251B-20 has 70 mJ at 1064 nm output energy. Inquire for these energies at other wavelengths.
³⁾ For -SH option. Outputs are not simultaneous. Please inquire for pulse energies at other wavelengths.
⁴⁾ For -TH option. Outputs are not simultaneous. Please inquire for pulse energies at other wavelengths.
⁵⁾ For -FH option. Outputs are not simultaneous. Please inquire for pulse energies at other wavelengths.
⁶⁾ For PL2250 series laser with custom -FiH option.

⁷⁾ Averaged from pulses, emitted during 30 sec time interval.
⁸⁾ FWHM. Inquire for optional pulse durations in 20 – 90 ps range. Pulse energy specifications may differ from indicated here.
⁹⁾ Measured over 1 hour period when ambient temperature variation is less than ±1 °C.
¹⁰⁾ With respect to TRIG1 OUT pulse. <10 ps jitter is provided optionally with PRETRIG feature.
¹¹⁾ With respect to SYNC IN pulse.
¹²⁾ TRIG1 OUT lead or delay can be adjusted with 0.25 ns steps in specified range.
¹³⁾ Average of X- and Y-plane full angle divergence values measured at the 1/e² level at 1064 nm.
¹⁴⁾ Beam pointing stability is evaluated from fluctuations of beam centroid position in the far field.
¹⁵⁾ Beam diameter is measured at 1064 nm at the 1/e² point.



¹⁶⁾ Three phase 208 or 380 VAC mains are required for 50 Hz versions.

¹⁷⁾ For 10 Hz version.

If laser is optimised for pumping parametrical generator, maximum output energy may be different than specified for stand alone application.

OPTIONS

► **Option P20** provides 20 ps ± 10% output pulse duration. Pulse energies are 30% lower in comparison to the 30 ps pulse duration version. Linewidth <math>< 2 \text{ cm}^{-1}</math> at 1064 nm. See table below for pulse energy specifications:

Model	PL2251A-10	PL2251B-10	PL2251C -10
1064 nm	35 mJ	60 mJ	80 mJ
532 nm	17 mJ	30 mJ	40 mJ
355 nm	12 mJ	18 mJ	24 mJ
266 nm	5 mJ	8 mJ	10 mJ

► **Option P80** provides 80 ps ±10% output pulse duration. Pulse energy specifications as below:

Model	PL2251A	PL2251B	PL2251C
Pulse energy at 1064 nm	70 mJ	100 mJ	160 mJ

BEAM PROFILE

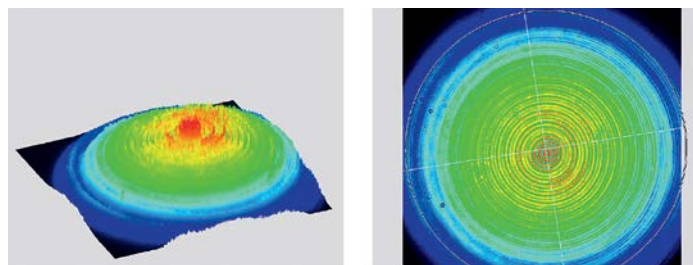

Fig 1. Typical near field output beam profile of PL2250 series laser

OUTLINE DRAWINGS

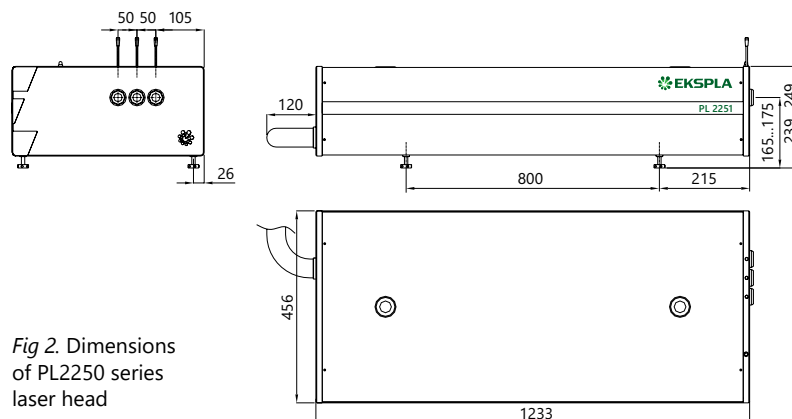
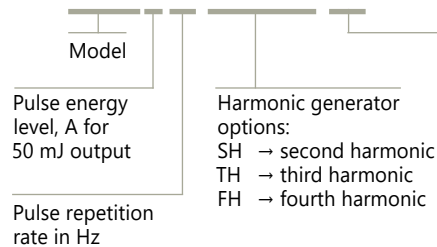

Fig 2. Dimensions of PL2250 series laser head

ORDERING INFORMATION

Note: Laser must be connected to the mains electricity all the time. If there will be no mains electricity for longer than 1 hour then laser (system) needs warm up for a few hours before switching on.

PL2251A-50-SH/TH/FH-P20



Other options:

- P20 → 20 ps pulse duration option
- P80 → 80 ps pulse duration option
- AW → water-air heat exchanger option
- FS → seeding option

**PRISM
AWARDS
FINALIST**



Photo: Single Housing MIR Tunable Picosecond Laser PT277-XIR integrate a picosecond optical parametric oscillator and DPSS pump laser into a single compact housing.

Picosecond Tunable Wavelength Lasers

For researchers demanding wide tuning range, high conversion efficiency and narrow line-width, EKSPLA PG&PT series optical parametric generators is an excellent choice. All models feature hands-free wavelength tuning, valuable optical components protection system as well as wide range of accessories and extension units.

Long-term experience and close cooperation with scientific institutions made it possible to create range of models, offering probably the widest tuning range: from 193 nm

to 16000 nm. Versions, offering near transform limited line-width as well as operating at kHz repetition rates are available.

For customer convenience the wavelength can be set from personal computer through USB (VCP, ASCII commands), RS232 (ASCII commands), LAN (REST API) or RS232 (ASCII commands), LAN (REST API) depending on the system configuration or from remote control pad with backlit display that is easy to read even while wearing laser safety glasses.

EKSPLA PL series picosecond mode-locked lasers are recommended for pumping of PG series Optical Parametric Generators. Combining together, researchers get complete tunable wavelength system, capable to assist researchers in wide range of spectroscopy applications: time-resolved pump-probe, nonlinear, infrared spectroscopy, laser-induced fluorescence.

SHORT SELECTION GUIDE

For Your convenience, table contains all available options and highest parameter values. Not all output specifications are available at the same time simultaneously. Please refer to the catalog page for exact specifications and available options.

Model	Output wavelength range	Max pulse repetition rate	Linewidth	Special feature	Page
PGx01	193 – 16000 nm	50 Hz	$< 6 \text{ cm}^{-1}$	High peak power ($>50 \text{ MW}$), ideal for non-linear spectroscopy	16
PGx11	193 – 16000 nm	50 Hz or 1000 Hz	$< 2 \text{ cm}^{-1}$	Narrow linewidth ($<0.8 \text{ cm}^{-1}$ on some versions)	20
PT277-XIR	1400 – 16000 nm	87 MHz	$< 5 \text{ cm}^{-1}$	Picosecond MHz rate MIR range laser system	25
PT277	1400 – 2050, 2200–4450 nm	87 MHz	$< 2.5 \text{ cm}^{-1}$	Optional intensity modulation up to 2 MHz	27
PT403	210 – 2300 nm	1000 Hz	$< 9 \text{ cm}^{-1}$	Pump laser and OPG integrated in 2-in-1 combo housing	29

PGx01 SERIES

High Energy Broadly Tunable OPA



Travelling Wave Optical Parametric Generators (TWOPG) are an excellent choice for researchers who need an ultra-fast tunable coherent light source from UV to mid IR.

Design

The units can be divided into several functional modules:

- ▶ optical parametric generator (OPG);
- ▶ diffraction grating based linewidth narrowing system (LNS);
- ▶ optical parametric amplifier (OPA);
- ▶ electronic control unit.

The purpose of the OPG module is to generate parametric superfluorescence (PS). Spectral properties of the PS are determined by the properties of a nonlinear crystal and usually vary with the generated wavelength. In order to produce narrowband radiation, the output from OPG is narrowed by LNS down to 6 cm^{-1} and then used to seed OPA.

Output wavelength tuning is achieved by changing the angle of the nonlinear crystal(s) and grating. To ensure exceptional wavelength reproducibility, computerized control unit driven precise stepper motors rotate the nonlinear crystals and diffraction grating. Nonlinear crystal

temperature stabilization ensures long-term stability of the output radiation wavelength.

In order to protect nonlinear crystals from damage, the pump pulse energy is monitored by built-in photodetectors, and the control unit produces an alert signal when pump pulse energy exceeds the preset value.

For customer convenience the laser can be operated from master device or personal computer through USB (VCP, ASCII commands), RS232 (ASCII commands), LAN (REST API) or RS232 (ASCII commands), LAN (REST API) depending on the system configuration or from remote control pad with backlit display that is easy to read even while wearing laser safety glasses.

Available models

Model	Features
PG401	Model has a tuning range from 420 to 2300 nm and is optimized for providing highest pulse energy in the visible part of the spectrum. The wide tuning range makes PG401 units suitable for many spectroscopy application.
PG501-DFG	Model has a tuning range from 2300 to 16000 nm. The PG501-DFG1 model is the optimal choice for vibrational-SFG spectroscopy setups.

FEATURES

- ▶ Ultra-wide spectral range from 193 to 16000 nm
- ▶ High peak power (>50 MW) ideal for non-linear spectroscopy applications
- ▶ Narrow linewidth <math> < 6 \text{ cm}^{-1}</math> (for UV <math> < 9 \text{ cm}^{-1}</math>)
- ▶ Motorized hands-free tuning in 193–2300 nm or 2300–16000 nm range
- ▶ PC control
- ▶ Remote control via keypad

APPLICATIONS

- ▶ Nonlinear spectroscopy: vibrational-SFG, surface-SH, Z-scan
- ▶ Pump-probe experiments
- ▶ Laser-induced fluorescence (LIF)
- ▶ Other laser spectroscopy applications

SPECIFICATIONS ¹⁾

Model	PG401	PG401-SH	PG401-DUV	PG501-DFG1
Tuning range				
DUV	-		193–209.95 nm	-
SH	-	210–340, 370–419 nm	-	
Signal	420 – 680 nm	-		
Idler	740 – 2300 nm	-		
DFG	-			2300–10000 nm
Output pulse energy ²⁾	> 1000 µJ at 450 nm	> 100 µJ at 300 nm	> 50 µJ at 200 nm	> 200 µJ at 3700 nm, > 30 µJ at 10000 nm
Linewidth	< 6 cm ⁻¹	< 9 cm ⁻¹		< 6 cm ⁻¹
Max pulse repetition rate	50 Hz			
Scanning step				
Signal	0.1 nm	-		
Idler	1 nm	-		
Typical beam size ³⁾	~4 mm	~3 mm		~9 mm
Beam divergence ⁴⁾	< 2 mrad			
Beam polarization	-	vertical		horizontal
Signal	horizontal	-		
Idler	horizontal	-		
Typical pulse duration	~20 ps			
PUMP LASER REQUIREMENTS				
Pump energy				
at 355 nm	10 mJ		-	
at 532 nm	-		10 mJ	
at 1064 nm	-	2 mJ		6 mJ
Recommended pump source ⁵⁾	PL2231-50-TH, PL2251A-TH			PL2231-50-SH, PL2251A-SH
Beam divergence	< 0.5 mrad			
Beam profile	homogeneous, without hot spots, Gaussian fit > 90 %			
Pulse duration ⁶⁾	29 ± 5 ps			
PHYSICAL CHARACTERISTICS				
Size (W x L x H)	456 × 633 × 244 mm		456 × 1031 × 249 ± 3 mm	
OPERATING REQUIREMENTS				
Room temperature	15 – 30 °C			
Power requirements	100 – 240 V AC single phase, 47 – 63 Hz			
Power consumption	< 100 W			

¹⁾ Due to continuous improvement, all specifications are subject to change without notice. Parameters marked typical are not specifications. They are indications of typical performance and will vary with each unit we manufacture. Unless stated otherwise, all specifications are measured at 450 nm for PG401 units, 3000 nm for PG501 units and 300 nm for PG401SH units and for basic system without options.

²⁾ See tuning curves for typical pulse energies at other wavelengths. Higher energies are available, please contact Ekspla for more details.

³⁾ Beam diameter is measured at the 1/e² level.

⁴⁾ Full angle measured at the FWHM point.

⁵⁾ If a pump laser other than PL2250 or PL2230 is used, measured beam profile data should be presented when ordering.

⁶⁾ Should be specified if non-EKSPLA pump laser is used.



CUSTOMIZED FOR SPECIFIC REQUIREMENTS

Please note that these products are custom solutions tailored for specific applications or specific requirements.

Interested? Tell us more about your needs and we will be happy to provide you with tailored solution.

PG401-DFG1 provides:

- ▶ The broadest hands-free tuning range – from 420 to 10000 nm
- ▶ It can be further extended up to 16000 nm with -DFG2 option. It should be noted, that for the 8000 – 16000 nm range a different nonlinear crystal is used, and exchange of the crystals needs to be done manually

PG402 features:

- ▶ Gap-free tuning range 410 – 709, 710 – 2300 nm
- ▶ Linewidth < 18 cm⁻¹

TUNING CURVES

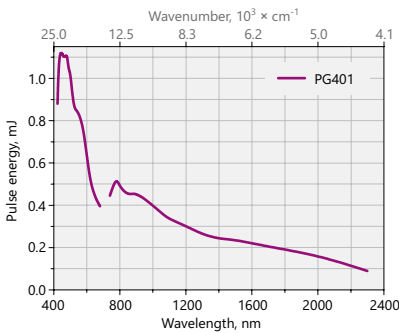

Fig 1. Typical PG401 model tuning curve
Pump energy: 10 mJ at 355 nm

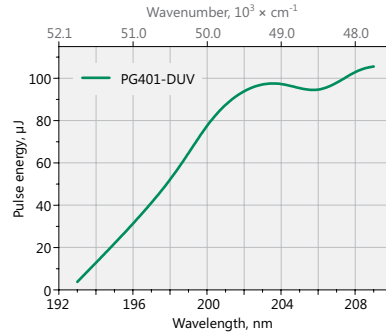

Fig 2. Typical PG401-DUV model tuning curve

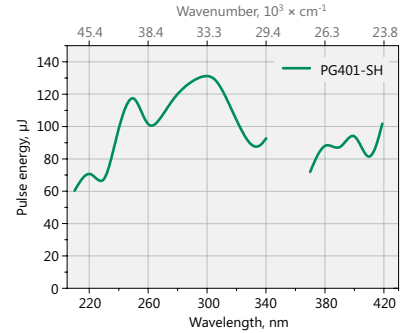

Fig 3. Typical PG401-SH model tuning curve. Pump energy: 10 mJ at 355 nm

Note: The energy tuning curves are affected by air absorption due narrow linewidth. These pictures present pulse energies where air absorption is negligible.

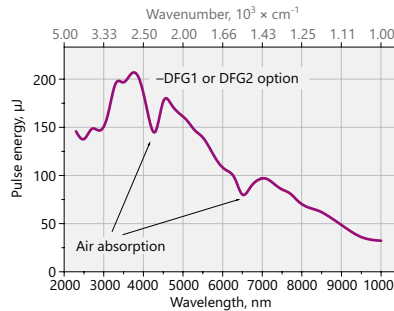

Fig 4. Typical PG501-DFG1 tuning curve

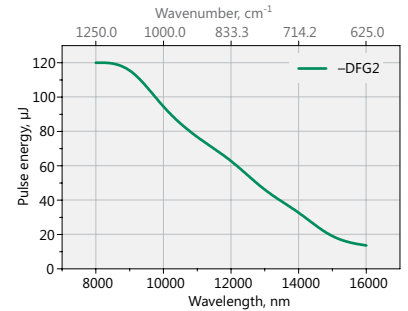

Fig 5. Typical PG501-DFG2 tuning curve in 8000–16000 nm range
Pump energy: 15 mJ at 1064 nm

RECOMMENDED UNITS ARRANGEMENT ON OPTICAL TABLE

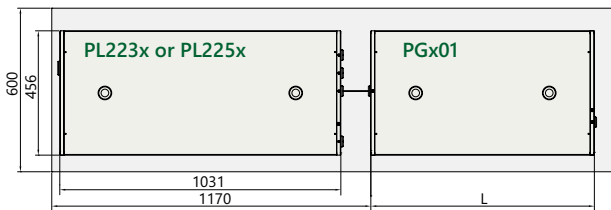

Fig 6a. Arrangement of pump laser and PGx01 unit on optical table

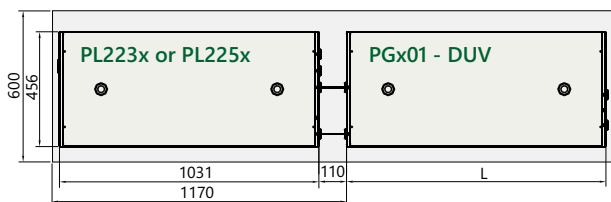

Fig 6b. Arrangement of pump laser and PGx01-DUV unit on optical table

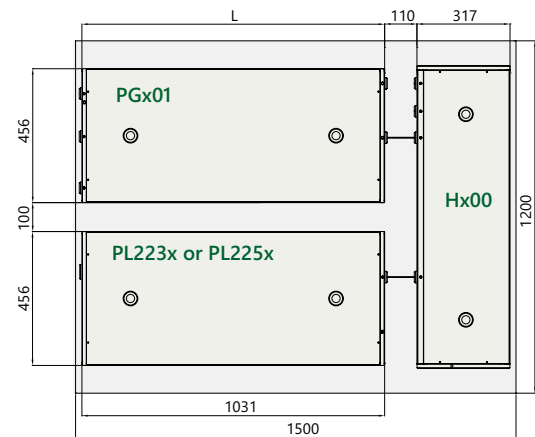

Fig 7. Recommended arrangement of pump laser and PGx01-DFGx unit on optical table

OUTLINE DRAWINGS

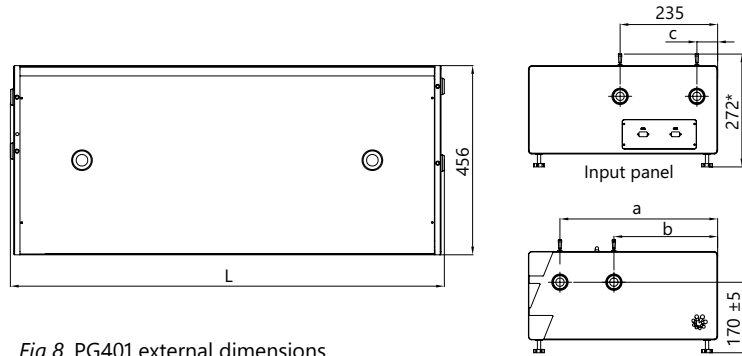

Fig 8. PG401 external dimensions

OUTPUTS PORTS

Model	L, mm	a, mm	b, mm	c, mm	Port 1	Port 2
PG401	633	380	x	x	420–680 nm, 740–2300 nm	–
PG401-SH	838	380	x	x	210–340 nm, 370–419.9 nm, 420–680 nm, 740–2300 nm	–
PG401-SH/DUV	1026	380	250	50	210–340 nm, 370–419 nm, 420–680 nm, 740–2300 nm	192–209.95 nm

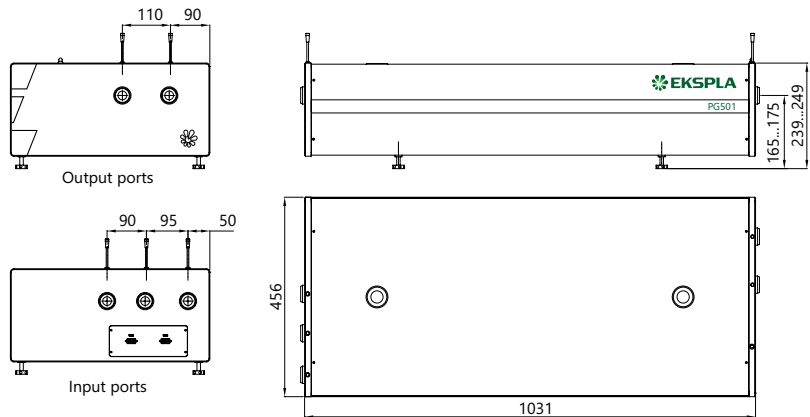

Fig 9. PG501 external dimensions

For SFG optional 532 nm output port 2.

ORDERING INFORMATION

PG401-DUV

Model
PG4xx → 355 nm pump

01 → travelling wave, narrowed linewidth
02 → travelling wave, not narrowed
11 → synchronous pumping, narrowed

Optional tuning range extension
DUV → 193–209.95 nm
SH → 210–340 nm & 370–420 nm

Custom products, tailored for specific applications. Inquire for other specifications.

DFG1 → 2300–10000 nm; >250 μJ at 3700 nm
DFG2 → 2300–16000 nm

PG501-DFG1

Model
PG5xx → 532 nm pump

01 → travelling wave, narrowed linewidth

Tuning range
DFG1 → 2300–10000 nm; >200 μJ at 3700 nm
DFG2 → 2300–16000 nm

Note: Laser must be connected to the mains electricity all the time. If there will be no mains electricity for longer than 1 hour then laser (system) needs warm up for a few hours before switching on.

PGx11 SERIES

Transform Limited
Broadly Tunable
Picosecond OPA

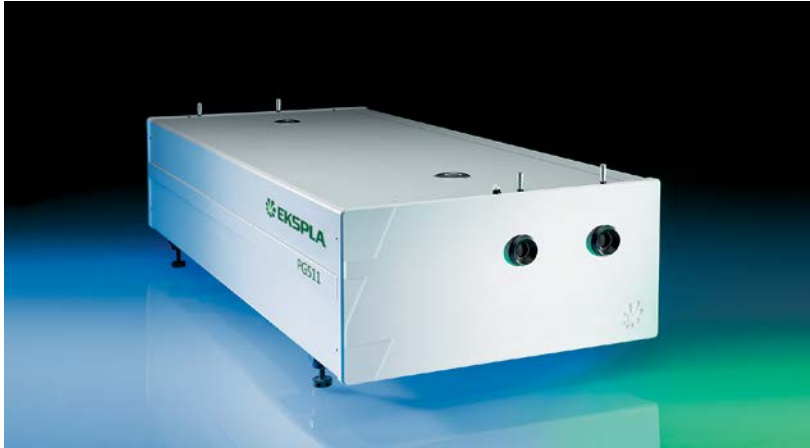

PGx11 series optical parametric devices employ advanced design concepts in order to produce broadly tunable picosecond pulses with nearly Fourier-transform limited linewidth and low divergence. High brightness output beam makes the PGx11 series units an excellent choice for advanced spectroscopy applications.

Optical layout of PGx11 units consists of Synchronously pumped Optical Parametric Oscillator (SOPO) and Optical Parametric Amplifier (OPA). SOPO is pumped by a train of pulses at approx. 87 MHz pulse repetition rate. The output from SOPO consists of a train of pulses

with excellent spatial and spectral characteristics, determined by the SOPO cavity parameters.

OPA is pumped by a single pulse temporally overlapped with SOPO output. After amplification at SOPO resonating wavelength, the PGx11 output represents a high intensity single pulse on top of a low-intensity train, while in all other spectral ranges (idler for PG411 and PG711, signal for PG511, also DFG stages) only a single high intensity pulse is present.

Three models designed for pumping by up to the 3rd harmonic of Nd:YAG laser are available.

FEATURES

- ▶ 2 cm^{-1} or 1 cm^{-1} linewidth
- ▶ High brightness picosecond pulses at 50 Hz or at up to 1 kHz pulse repetition rate
- ▶ Nearly Fourier-transform limited linewidth
- ▶ Low divergence <2 mrad
- ▶ Hands-free wavelength tuning
- ▶ Tuning range from 193 nm to 16000 nm
- ▶ PC control
- ▶ Remote control via keypad

APPLICATIONS

- ▶ Time resolved pump-probe spectroscopy
- ▶ Laser-induced fluorescence
- ▶ Infrared spectroscopy
- ▶ Nonlinear spectroscopy: vibrational-SFG, surface-SH, Z-scan, pump probe
- ▶ Other laser spectroscopy applications

Available models

Model	Features
PG411	Model has a tuning range from 410 to 2300 nm and is optimized for providing highest pulse energy in the visible part of the spectrum. When combined with an optional Second Harmonic Generator (SHG) and Sum Frequency Generator (-DUV), it offers the widest possible tuning range – from 193 to 2300 nm.
PG511	Model has a tuning range 2300–10000 nm. PG411 and PG511 models are designed to be pumped by PL2230 series lasers with a 50 Hz pulse repetition rate.
PG711	Model has 1 kHz pulse repetition rate and uses DPSS mode-locked laser of the PL2210 series for pumping. When pumped with pulses of 90 ps duration, linewidths of less than 1 cm^{-1} were measured in the spectral range up to 16 μm , which makes this device an excellent choice for time-resolved or nonlinear infrared spectroscopy.

Microprocessor based control system provides automatic positioning of relevant components, allowing hands free operation. Nonlinear crystals, diffraction grating and filters are rotated by ultra-precise stepper motors in microstepping mode, with excellent reproducibility.

Precise nonlinear crystal temperature stabilization ensures long-term stability of generated wavelength and output power.

For customer convenience the system can be controlled through USB (VCP, ASCII commands), RS232 (ASCII commands), LAN (REST API)

or RS232 (ASCII commands), LAN (REST API) depending on the system configuration or a remote control pad. Both options allow easy control of system settings.

Available standard models are summarized in a table below. Please inquire for custom-built versions.

SPECIFICATIONS ¹⁾

Model	PG411	PG411-SH	PG411-SH-DUV	PG511-DFG	PG711	PG711-DFG
Output wavelength tuning range						
SH, DUV	–	210–410 nm	193–410 nm		–	
Signal		410–709 nm		–	1550–2020 nm	
Idler		710–2300 nm		–	2250–3350 nm	
DFG		–		2300–10000 nm	–	3350–16000 nm
DFG2 (up to 16000 nm)		–		inquire	–	–
Output pulse energy ²⁾						
SH, DUV	–	100 µJ ³⁾	50 µJ ³⁾		–	
Signal		700 µJ		–	500 µJ	
Idler ⁴⁾		250 µJ		–	100 µJ	
DFG		–		> 200 µJ at 3700 nm, > 30 µJ at 10000 nm	–	20 µJ ⁵⁾
Max pulse repetition rate		50 Hz		50 Hz	1000 Hz	
Linewidth		< 3 cm ⁻¹ ⁶⁾		< 2 cm ⁻¹	< 1 cm ⁻¹	
Linewidth Idler		< 5 cm ⁻¹ ⁶⁾			–	
Typical pulse duration ⁷⁾		~20 ps		~20 ps	~70 ps	
Scanning step						
SH, DUV	–	0.01 nm			–	
Signal				0.1 nm		
Idler				1 nm		
DFG		–			1 nm	
Typical beam diameter ⁸⁾		~ 4 mm		~ 9 mm	~ 3 mm	
Beam divergence ⁹⁾		< 2 mrad				
Beam polarization ⁹⁾						
SH, DUV	–	vertical			–	
Signal		horizontal		vertical	horizontal	
Idler		vertical		horizontal	vertical	
DFG		–		horizontal	–	horizontal

¹⁾ Due to continuous improvement, all specifications are subject to change without notice. Parameters marked typical are not specifications. They are indications of typical performance and will vary with each unit we manufacture. Unless stated otherwise, all specifications are measured at 450 nm for PG411 units, 800 nm for PG511 units, and 1620 nm for PG711 units and for basic system without options.

²⁾ Pulse energies are specified at selected wavelengths. See typical tuning curves for pulse energies at other wavelengths.

³⁾ Measured at 280 nm for SH and 200 nm for DUV.

⁴⁾ Measured at 1000 nm for PG411 units, 1620 nm for PG511, and 3000 nm for PG711 units.

⁵⁾ Measured at 10000 nm.

⁶⁾ Linewidth for signal (409 – 710 nm) < 3 cm⁻¹, linewidth for idler and SH-DUV (710 – 2300 nm and 193 – 409 nm) < 5 cm⁻¹.

⁷⁾ Estimated FWHM assuming pump pulse duration 30 ps at 1064 nm for PG411 and PG511 units, and 90 ps at 1064 nm for PG711 units.

⁸⁾ Beam diameter is measured at 1/e² level and can vary depending on the pump pulse energy.

⁹⁾ Full angle measured at FWHM level.



SPECIFICATIONS ¹⁾

Model	PG411	PG411-SH	PG411-SH-DUV	PG511-DFG	PG711	PG711-DFG
PUMP LASER REQUIREMENTS						
Recommended pump source	PL2231 + APL2100-TRAIN-H411			PL2231 + H500-APL2100-TRAIN	PL2211A TR	
Min. pump energy or power ¹⁰⁾						
at 1064 nm	-		2 mJ	(10 mJ)	5 mJ at 1 kHz	
at 532 nm	-			5 mJ (8 mJ)		
at 355 nm	5 mJ (10 mJ)			-		
Pulse duration ¹¹⁾	29 ± 5 ps				90 ps	
Bream polarization at pump wavelength	vertical			horizontal		
Beam size ¹²⁾	7 mm				2.5 mm	
Beam divergence	< 0.5 mrad					
Beam profile	homogeneous, without hot spots					
PHYSICAL CHARACTERISTICS						
Size (W × L × H)	456 × 1026 × 244 mm	456 × 1226 × 244 mm		PL2231: 456 × 1026 × 244 mm H500-APL2100-TRAIN: 456 × 1026 × 244 mm		456 × 1026 × 244 mm
OPERATING REQUIREMENTS						
Room temperature	15–30 °C					
Room temperature stability	± 2 °C					
Power requirements	100–240 V single phase, 47–63 Hz					
Power consumption	< 300 W					

¹⁰⁾ The first number represents pulse train energy or power, while the value in brackets represents single pulse energy.

¹¹⁾ At FWHM level. Inquire for other available pulse duration options.

¹²⁾ Beam diameter measured at 1/e² level.

RECOMMENDED UNITS ARRANGEMENT ON OPTICAL TABLE

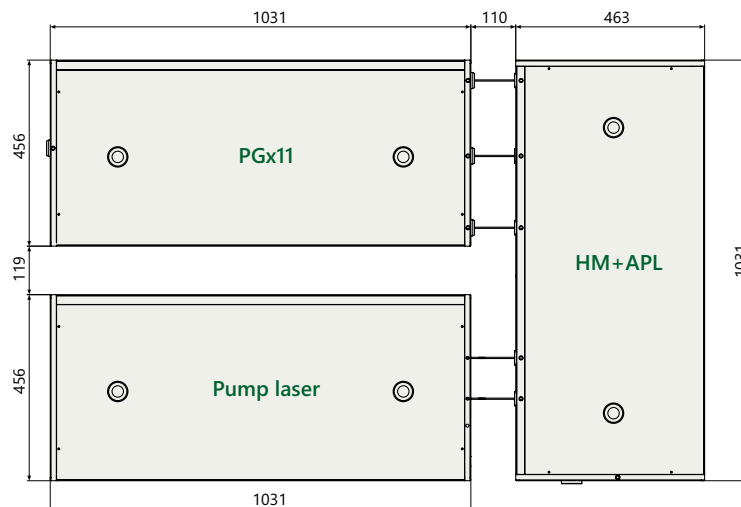

Fig 1. Arrangement of pump laser and PGx11 unit on optical table

TUNING CURVES

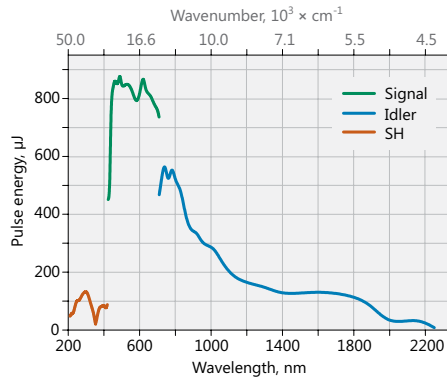

Fig 2. Typical PG411-SH model tuning curve

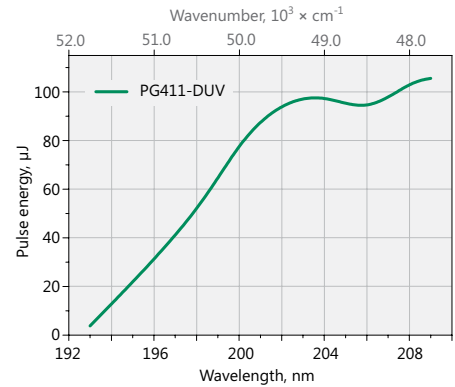

Fig 3. Typical PG411-DUV model tuning curve

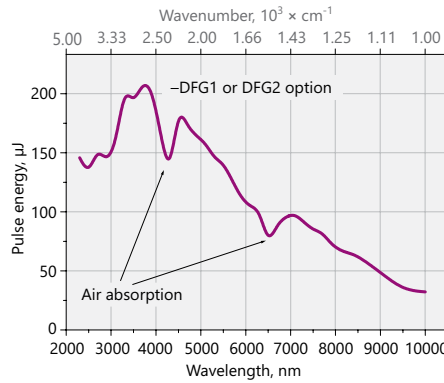

Fig 4 Typical PG511-DFG model tuning curve

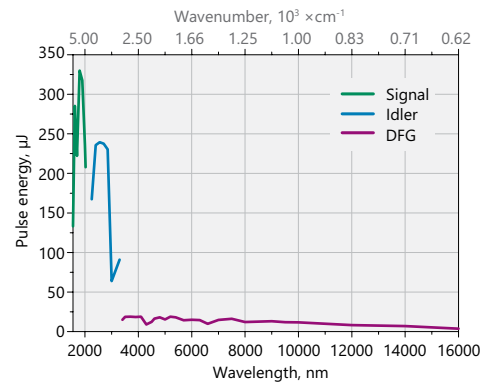

Fig 5. Typical PG711-DFG model tuning curve.

Pump energy: 2.5 mJ at 1064 nm, 1 kHz repetition rate

Note: The energy tuning curves are affected by air absorption due narrow linewidth. These pictures present pulse energies where air absorption is negligible.

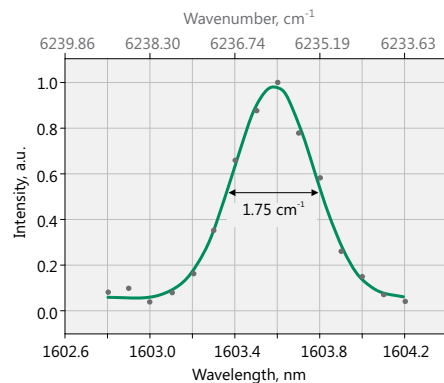

Fig 6. PG511-DFG model typical output linewidth

OUTLINE DRAWINGS

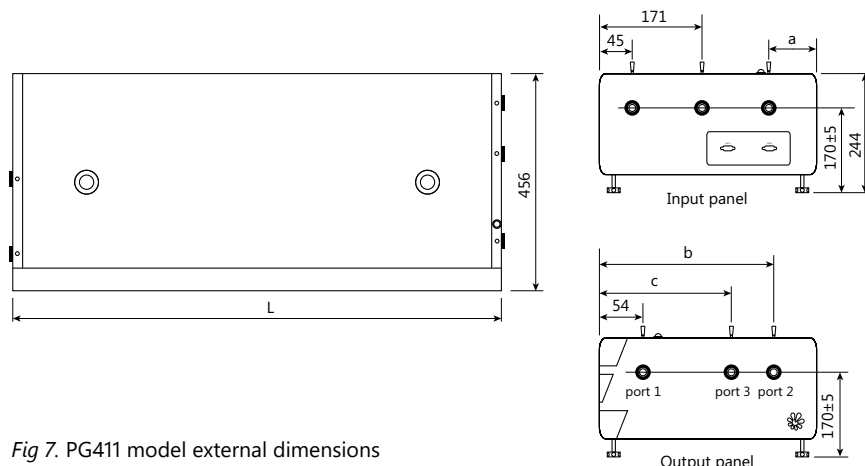

Fig 7. PG411 model external dimensions

OUTPUTS PORTS

Model	L, mm	a, mm	b, mm	c, mm	Port 1	Port 2	Port 3
PG411	1026	x	411	x	420–709 nm, 710–2300 nm	420–709 nm, 710–2300 nm	–
PG411-SH	1226	x	411	x	420–709 nm, 710–2300 nm	210–419 nm, 420–709 nm, 710–2300 nm	–
PG411-SH/DUV	1226	235	411	331	420–709 nm, 710–2300 nm	210–419 nm, 420–709 nm, 710–2300 nm	192–209.95 nm

ORDERING INFORMATION

Note: Laser must be connected to the mains electricity all the time. If there will be no mains electricity for longer than 1 hour then laser (system) needs warm up for a few hours before switching on.

PGx11-SH

Model	Optional tuning range extension
PG411 → ps 355 nm pump	SH (PG411) → 210–420 nm
PG511 → ps 532 nm pump	SH/DUV (PG411) → 193–420 nm
PG711 → ps 1064 nm pump	DFG (PG511) → 2300–10000 nm
	DFG (PG711) → 3350–16000 nm

PT277-XIR SERIES

Single Housing
MIR (mid infrared
range) Tunable
Picosecond Laser



PT277 series laser systems integrate a picosecond optical parametric oscillator and DPSS pump laser into a single compact housing. Mounting the components into one frame provides a cost-effective and robust solution. It makes laser installation shorter and improves long-term stability, reduces maintenance costs. The tuning range for the model PT277-XIR 1405 – 2020 nm, 2250 – 4400 nm, 5000 – 16000 nm (7115 – 4950 cm^{-1} , 4444 – 2253 cm^{-1} , 2000 – 625 cm^{-1}) with linewidth $<5 \text{ cm}^{-1}$ in the full tuning range.

The fast wavelength tuning is based on the microprocessor-control and wavelength tuning is fully automatic. The wavelength tuning elements are mounted on precise closed loop micro stepping motors. The temperatures of the non linear crystals is controlled by a precise thermocontrollers. For customer convenience the system can be controlled via keypad and/or any controller running on any OS using REST API commands. Variety of interfaces USB, RS232, LAN, WLAN (optionally) ensures easy control and integration with other equipment.

FEATURES

- ▶ 1405 – 16000 nm (7115 – 625 cm^{-1}) tuning range
- ▶ Linewidth $<5 \text{ cm}^{-1}$ in the full tuning range
- ▶ Nearly diffraction limited divergence
- ▶ Remote control via keypad and/or any controller running on any OS using REST API commands
- ▶ PC control via USB (virtual com port), RS232, LAN

APPLICATIONS

- ▶ Infrared spectroscopy

TUNING CURVES

Fig 1. Typical output PT277-XIR tuning curve.
The actual tuning curve might differ from presented here.

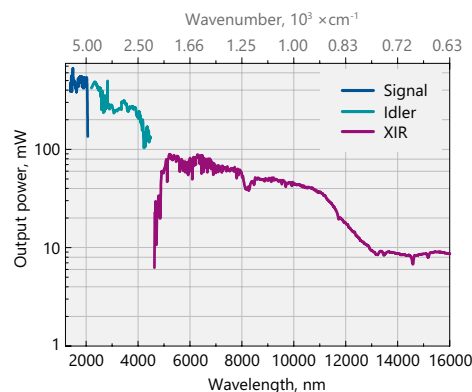

SPECIFICATIONS

Model	PT277 - XIR
SYNCHRONOUSLY PUMPED OPO SPECIFICATIONS ¹⁾	
Tuning range	
Signal	1405 – 2020 nm (7115 – 4950 cm ⁻¹)
Idler	2250 – 4400 nm (4444 – 2253 cm ⁻¹)
XIR	5000 – 16000 nm (2000 – 625 cm ⁻¹)
Linewidth	< 5 cm ⁻¹
Output power ²⁾	
OPO @ 4000 nm (2500 cm ⁻¹)	> 100 mW @ 2200 – 4000 nm
OPO @ 12500 nm (800 cm ⁻¹)	> 10 mW
Pulse repetition rate	87 MHz
Pulse duration (pump laser)	~8 ps
Scanning step	
Signal	0.1 nm
Idler, XIR	1 nm
Polarization	vertical
Typical beam diameter ^{3) 4)}	~3 mm
Typical beam divergence ⁵⁾	< 5 mrad (for signal)
Beam pointing stability	< 50 μrad rms @ 1596 nm
AOM modulation	0 Hz – 2 MHz
Fast spectral scan, scan speed (for spectral range)	
Idler	< 2 s
XIR	< 1 s
PHYSICAL CHARACTERISTICS	
Unit size (W×L×H)	320 × 766 × 241 mm
Power supply size (W×L×H)	483 × 140 × 390 mm
Umbilical length	2.5 m
OPERATING REQUIREMENTS	
Cooling	water-air (by provided chiller)
Room temperature	22 ± 2 °C
Room temperature stability	± 1 °C
Relative humidity	20 – 80 % (noncondensing)
Power requirements	100 – 240 VAC (-10% / +5%), single phase, 50/60 Hz
Power consumption	< 1 kVA
Cleanness of the room	not worse than ISO Class 9

- ¹⁾ All specifications are subject to change without notice. The parameters marked typical are not specifications. They are indications of typical performance and will vary with each unit we manufacture. Unless stated otherwise all specifications are measured at 1596 nm.
- ²⁾ Output powers are specified at selected wavelengths. See typical tuning curves for power at other wavelengths.
- ³⁾ Measured at 3000 nm.
- ⁴⁾ Beam diameter at the 1/e² level and can vary depending on the pump pulse energy.
- ⁵⁾ Full angle measured at the FWHM level.

Note: Laser must be connected to the mains electricity all the time. If there will be no mains electricity for longer than 1 hour then laser (system) needs warm up for a few hours before switching on. The laser and auxiliary units must be settled in such a place void of dust and aerosols. It is advisable to operate the laser in air conditioned room, provided that the laser is placed at a distance from air conditioning outlets. The laser should be positioned on a solid worktable. Access from both sides should be ensured. Intensive sources of vibration should be avoided, like railways station etc nearby laboratory.



OUTLINE DRAWINGS

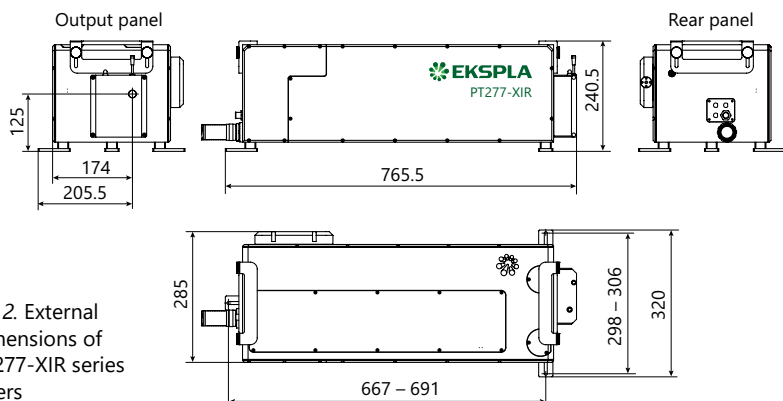

Fig 2. External dimensions of PT277-XIR series lasers

PT277 SERIES



PT277 series laser systems integrate a picosecond optical parametric oscillator and DPSS pump laser into a single compact housing. Mounting the components into one frame provides a cost-effective and robust solution with improved long-term stability and reduced maintenance costs.

The tuning range is for the model PT277 1400 – 2050 and 2200 to 4450 nm with nearly Fourier transform limited linewidth.

The microprocessor-controlled wavelength tuning is fully automatic. The wavelength controlling

elements are mounted on precise micro-stepping motors. The temperature of the non-linear crystal is controlled by a precise thermocontroller with a bidirectional Peltier element, resulting in the fast tuning of crystal temperature. For customer convenience the system can be controlled through USB (VCP, ASCII commands), RS232 (ASCII commands), LAN (REST API) or RS232 (ASCII commands), LAN (REST API) depending on the system configuration or a remote control pad. Both options allow easy control of system settings.

Single Housing
NIR-IR Range
Tunable
Picosecond Laser

FEATURES

- ▶ 1400–4450 nm tuning range
- ▶ Nearly Fourier transform-limited linewidth
- ▶ Nearly diffraction limited divergence
- ▶ Output wavelength monitoring (optional)
- ▶ PC control

APPLICATIONS

- ▶ Infrared microscopy
- ▶ Infrared spectroscopy
- ▶ Near field spectroscopy

TUNING CURVES

Fig 1. Typical output power of PT277 tunable laser. The power is shown only at the wavelengths where ambient air absorption is negligible

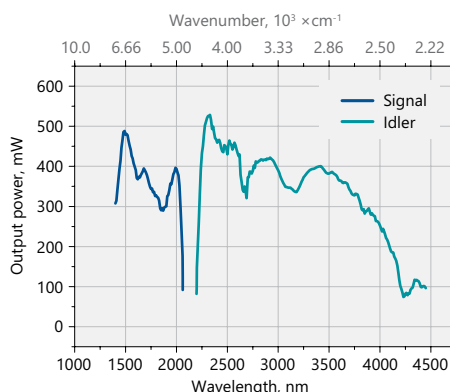

SPECIFICATIONS ¹⁾

Model	PT277
Pulse repetition rate ²⁾	87 MHz
Tuning range	
Signal	1400 – 2050 nm
Idler	2200 – 4450 nm
Output power ³⁾	
OPO ⁴⁾	> 500 mW
Linewidth ⁴⁾	< 2.5 cm ⁻¹
Typical pulse duration ^{4) 5)}	70 ps
Scanning step	
Signal	0.1 nm
Idler	0.1 nm
Polarization	
Signal beam	horizontal
Idler beam	horizontal
Typical beam diameter ^{4) 6)}	~2 mm
Typical beam diameter, Idler ^{4) 6)}	~5 mm
Typical beam divergence ^{4) 7)}	< 2 mrad
PHYSICAL CHARACTERISTICS	
Unit size (W × L × H)	370 × 800 × 260 mm
Power supply size (W × L × H)	520 × 500 × 290 mm
Umbilical length	2 m
OPERATING REQUIREMENTS	
Cooling	water-air
Room temperature	22 ± 2 °C
Relative humidity	20 – 80 % (noncondensing)
Power requirements	100 – 240 V AC, single phase 50/60 Hz
Power consumption	< 1 kVA

¹⁾ Due to continuous improvement, all specifications are subject to change without notice. Parameters marked 'typical' are indications of typical performance (not specifications) and will vary with each unit we manufacture. Unless stated otherwise, all specifications are measured at 1064 nm and for basic system without options.

²⁾ Inquire for custom pulse repetition rates.

³⁾ Output powers are specified at selected wavelengths. See typical tuning curves for power at other wavelengths.

⁴⁾ Measured at 1600 nm for PT277 model at signal range.

⁵⁾ Pulse duration can vary depending on wavelength and pump energy.

⁶⁾ Beam diameter at the 1/e² level and can vary depending on the pump pulse energy.

⁷⁾ Full angle measured at the FWHM level.

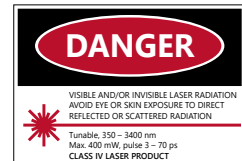

OUTLINE DRAWINGS

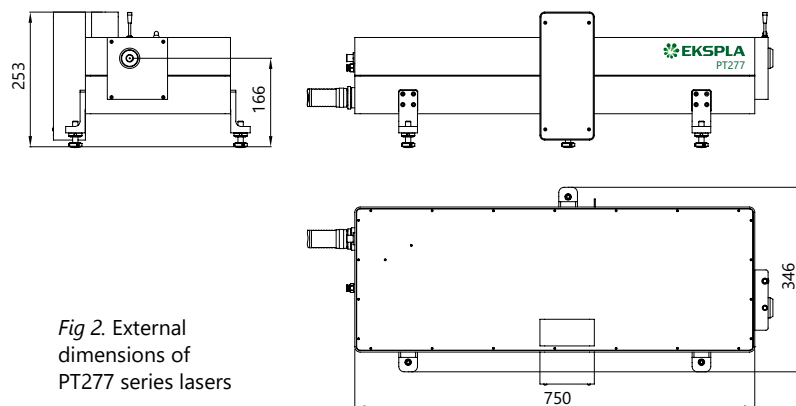

Note: Laser must be connected to the mains electricity all the time. If there will be no mains electricity for longer than 1 hour then laser (system) needs warm up for a few hours before switching on.

Fig 2. External dimensions of PT277 series lasers

PT403 SERIES



PT403 series laser systems integrate a picosecond 1 kHz repetition rate DPSS pump laser and optical parametric generator into a single housing. New picosecond tunable wavelength laser system provide from 210 to 2300 nm from the one box.

Unlike other solutions in the market, offering laser and OPO in different units, new approach features pump laser and OPO integrated into one unit. That delivers almost twice smaller footprint, shorter installation, better stability and other substantial benefits for user.

All-in one-box solution features all components placed into one compact housing. It means better overall stability because all potential causes for misalignment between separate units of pump laser and optical parametric generator are eliminated.

To ensure reliability industry and market tested solutions were employed during the build-up of PT403.

Pump laser is based on industry "gold standard" diode pumped Ekspla PL2210 series picosecond mode-locked laser. Improved output parameters and reduced maintenance costs are achieved by employing diode-pumped-only technology.

Optical parametric generator is based on PGx03 picosecond optical parametric amplifier systems. Fully automatized and microprocessor based control system ensures hands free precise wavelength tuning.

PT403 was built without sacrificing any parameters or reliability. The optical design is optimized to produce low divergence beams with moderate linewidth (typically $< 9 \text{ cm}^{-1}$) at approximately 20 ps pulse duration. Featuring 1 kHz repetition rate PT403 tuneable laser is versatile cost-efficient tool for scientists researching various kind of disciplines like time resolved fluorescence, pump-probe spectroscopy, laser-induced fluorescence, Infrared spectroscopy and other applications.

Simple and convenient laser control

For customer convenience the laser can be operated from master device or personal computer through USB (VCP, ASCII commands), RS232 (ASCII commands), LAN (REST API) or RS232 (ASCII commands), LAN (REST API) depending on the system configuration or from remote control pad with backlit display that is easy to read even while wearing laser safety glasses.

Tunable Wavelength Picosecond Laser

FEATURES

- ▶ Tuning range: 210 – 2300 nm
- ▶ Motorized hands-free tuning
- ▶ High pulse energy at 1 kHz rates
- ▶ Diode pumped solid state design
- ▶ Narrow linewidth $< 9 \text{ cm}^{-1}$
- ▶ Remote control via keypad
- ▶ PC control
- ▶ Optional streak camera triggering pulse with $< 10 \text{ ps rms jitter}$
- ▶ Turn-key operation
- ▶ Air cooled – external water supply is not required
- ▶ Low maintenance costs

APPLICATIONS

- ▶ Time resolved fluorescence (including streak camera measurements), pump-probe spectroscopy
- ▶ Laser-induced fluorescence
- ▶ Infrared spectroscopy
- ▶ Nonlinear spectroscopy: surface-SH, Z-scan
- ▶ Other spectroscopic and nonlinear optics applications

BENEFITS

- ▶ Better long term stability (compared with layout where laser and OPO are in different units)
- ▶ Higher safety – all beams are in the box
- ▶ Shorter installation time
- ▶ Almost twice smaller footprint

SPECIFICATIONS ¹⁾

Model	PT403	PT403-SH
OPA SPECIFICATIONS		
Output wavelength tuning range		
SH	–	210 – 409 nm
Signal	410 – 709 nm	
Idler	710 – 2300 nm	
Output pulse energy ²⁾		
SH ³⁾	–	15 µJ
Signal ⁴⁾	> 75 µJ	
Idler ⁵⁾	> 25 µJ	
Pulse repetition rate	1000 Hz	
Linewidth	< 9 cm ⁻¹	< 12 cm ⁻¹
Typical pulse duration ⁶⁾	~ 20 ps	
Scanning step		
SH	–	0.05 nm
Signal	0.1 nm	
Idler	1 nm	
Typical beam size ⁷⁾	~ 2 mm	
Beam divergence ⁸⁾	< 2 mrad	
Beam pointing stability	≤ 100 µrad rms	
Beam polarization		
SH	–	horizontal
Signal	horizontal	
Idler	vertical	
Optical pulse jitter		
Internal triggering regime ⁹⁾	< 50 ps (StDev) in respect to TRIG1 OUT pulse	
External triggering regime	~ 3 ns (StDev) in respect to SYNC IN pulse	
TRIG1 OUT pulse delay ¹⁰⁾	-400 ... 150 ns	
OPERATING REQUIREMENTS		
Room temperature	22 ± 2 °C	
Relative humidity	20 – 80% (non-condensing)	
Power requirements	100 – 240 V single phase, 47 – 63 Hz	
Power consumption	< 0.6 kW	
Water service	air cooled	
Cleanness of the room	not worse than ISO Class 9	

¹⁾ Due to continuous improvement, all specifications are subject to change without notice. Parameters marked typical are not specifications. They are indications of typical performance and will vary with each unit we manufacture. Unless stated otherwise, all specifications are measured at 450 nm for PT403 units for basic system without options.
²⁾ Pulse energies are specified at selected wavelengths. See typical tuning curves for pulse energies at other wavelengths.
³⁾ Measured at 260 nm.

⁴⁾ Measured at 450 nm.
⁵⁾ Measured at 1000 nm.
⁶⁾ Estimated assuming 30 ps at 1064 nm pump pulse. Pulse duration varies depending on wavelength and pump energy.
⁷⁾ Beam diameter at the 1/e² level. Can vary depending on the wavelength.
⁸⁾ Beam divergence measured at FWHM.
⁹⁾ < 10 ps jitter is provided with PRETRIG option.
¹⁰⁾ TRIG1 OUT lead or delay can be adjusted with 0.25 ns steps in specified range.



Communication module interfaces

Interface	Description
USB	virtual serial port, ASCII commands
RS232	ASCII commands

Interface	Description
LAN	REST API
WLAN	REST API

DESIGN

The units can be divided into several functional parts:

1. 1 kHz repetition rate DPSS pump laser,
2. Optical parametric generator (OPG),
3. Electronic control unit.



Fig 1. PT403 unit

PT403 series laser systems integrate a picosecond 1 kHz repetition rate DPSS pump laser and optical parametric generator into a single housing. As pump laser is used PL2210 series diode-pumped, air-cooled, mode-locked Nd:YAG laser. Picosecond tunable wavelength laser system provide from 210 to 2300 nm from the single optical unit.

OPTIONS

► **Option SF**

Energy increasing in 300 – 409 nm range by sum-frequency generation. > 20 µJ @ 340 nm. Pulse energies are ~ 10 % lower in comparison to the system without SF option. See table below for pulse energy specifications:

Model ¹⁾	PT403	PT403-SH
SH ²⁾	–	> 13 µJ
Signal ³⁾		> 70 µJ
Idler ⁴⁾		> 22 µJ

¹⁾ Due to continuous improvement, all specifications are subject to change without notice. Parameters marked typical are not specifications. They are indications of typical performance and will vary with each unit we manufacture.

²⁾ Measured at 260 nm.

³⁾ Measured at 450 nm.

⁴⁾ Measured at 1000 nm.

► **Options -H, -2H, -3H**

1064 nm or 532 nm, or 355 nm outputs ^{1) 2)}

- H output energy 0.7 mJ;
- 2H output energy 0.3 mJ;
- 3H output energy 0.3 mJ.

¹⁾ Outputs are not simultaneous.

²⁾ Inquire for outputs simultaneously with PG.

CUSTOMIZED FOR SPECIFIC REQUIREMENTS

Please note that these products are custom solutions tailored for specific applications or specific requirements.

Interested? Tell us more about your needs and we will be happy to provide you with tailored solution.

PT503 FEATURES

- The higher pulse energy in the near-IR spectral range
- Tuning range from 700 to 2200 nm

TUNING CURVES

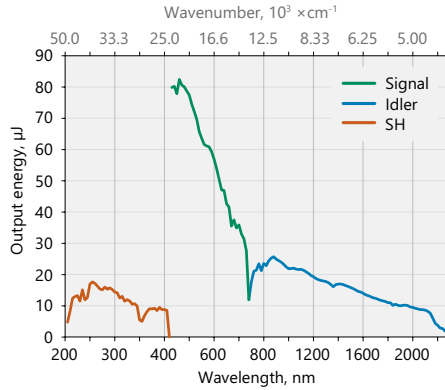

Fig 2. Typical PT403 tuning curves in signal (410 – 709 nm), idler (710 – 2300 nm) ranges, SH (210 – 409 nm) ranges

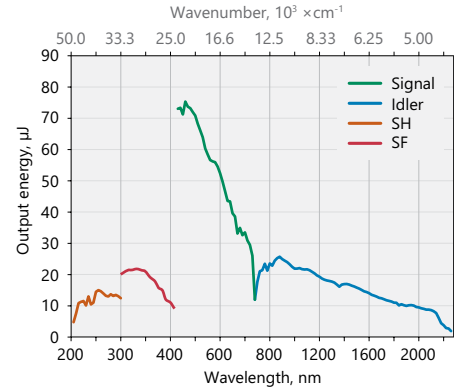

Fig 3. Typical PT403 tuning curves in signal (410 – 709 nm), idler (710 – 2300 nm) ranges, SH (210 – 300 nm), SF (300 – 409 nm) ranges

Note: The energy tuning curves are affected by air absorption due narrow linewidth. These pictures present pulse energies where air absorption is negligible.

OUTLINE DRAWINGS

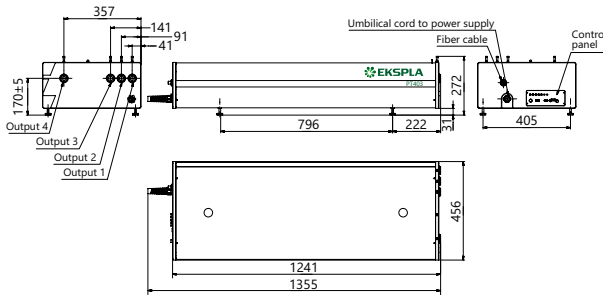

Fig 4. PT403 series laser head typical outline drawing

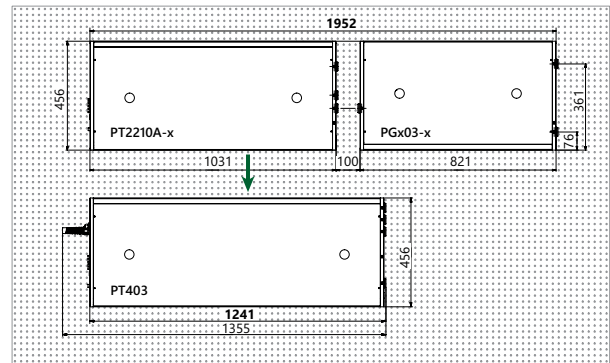

Fig 5. Compared with layout where laser and OPO are in different units, PT403 features almost twice smaller footprint

OUTPUTS PORTS

Model	L, mm	Port 1	Port 2	Port 3	Port 4
PT403	1241	1064 / 532 nm	–	355 nm	410 – 2300 nm
PT403-SH/SF	1441	1064 / 532 nm	210 – 2300 nm	355 nm	410 – 2300 nm

Note: Laser must be connected to the mains electricity all the time. If there will be no mains electricity for longer that 1 hour then laser (system) needs warm up for a few hours before switching on.

Nonlinear Spectroscopy Systems

Picosecond scanning

Femtosecond broadband

Spectral resolution
< 3 cm^{-1}

Continuously tunable
 $625 - 4300 \text{ cm}^{-1}$

Repetition rate
up to 1 kHz

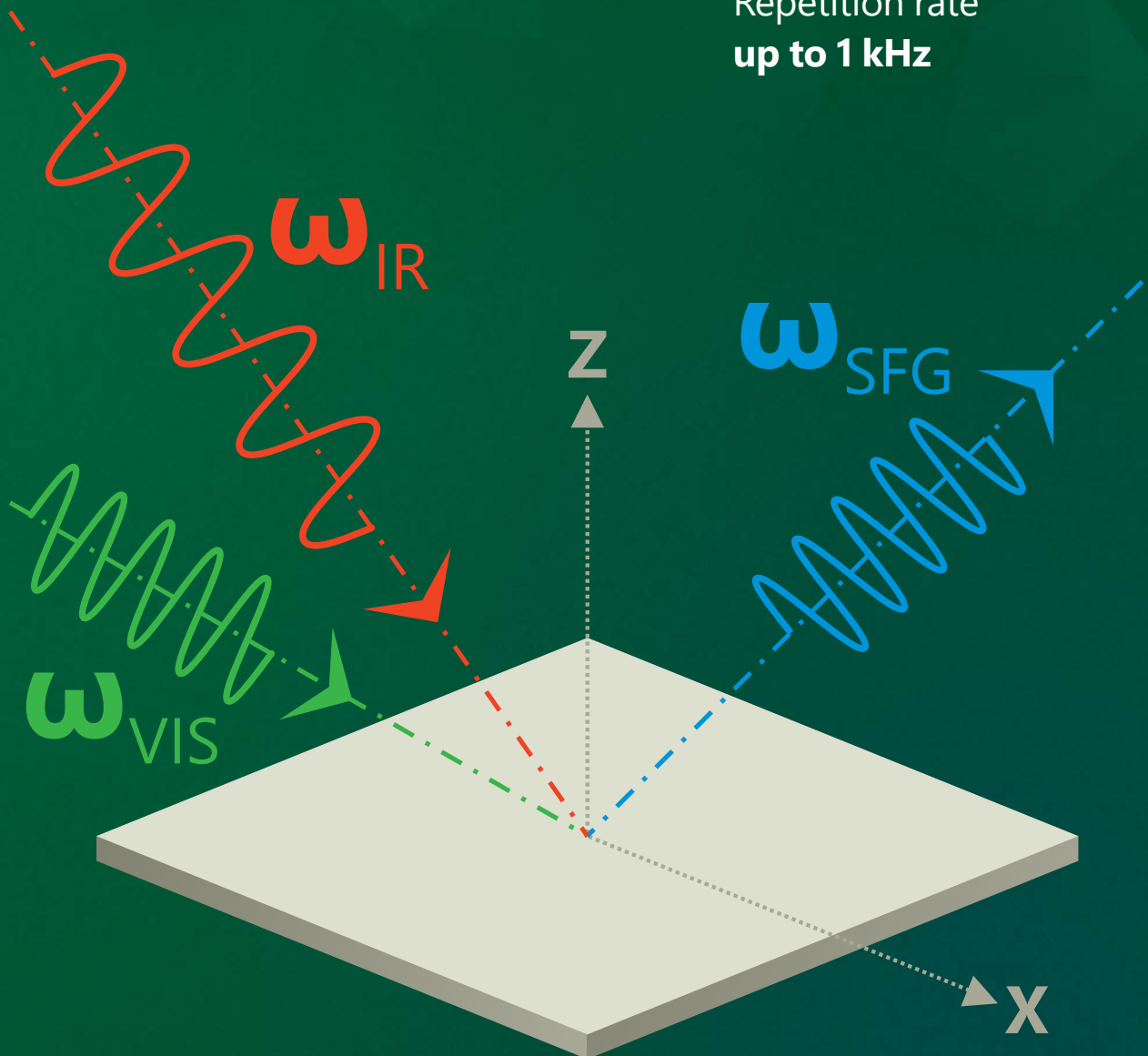

Sum Frequency Generation Vibrational Spectroscopy

Sum Frequency Generation Vibrational Spectroscopy (SFG-VS) is a powerful and versatile method for in-situ investigation of surfaces and interfaces. In SFG-VS experiment a pulsed tunable infrared IR (ω_{IR}) laser beam is mixed with a visible VIS (ω_{VIS}) beam to produce an output at the sum frequency ($\omega_{SFG} = \omega_{IR} + \omega_{VIS}$). SFG is a second order nonlinear process, which is allowed only in media without inversion symmetry. At surfaces or interfaces inversion symmetry is necessarily broken, that makes SFG highly surface specific. As the IR wavelength is scanned, active vibrational modes of molecules at the

interface give a resonant contribution to SF signal. The resonant enhancement provides spectral information on surface characteristic vibrational transitions.

Vibrational sum frequency generation (SFG) spectroscopy holds several important advantages over traditional spectroscopy methods for the molecular level analysis of interfaces, including (i) surface sensitivity, (ii) vibrational specificity, and (iii) the possibility to extract detailed information on the ordering and orientation of molecular groups at the interface by analysis of polarization-dependent SFG spectra.

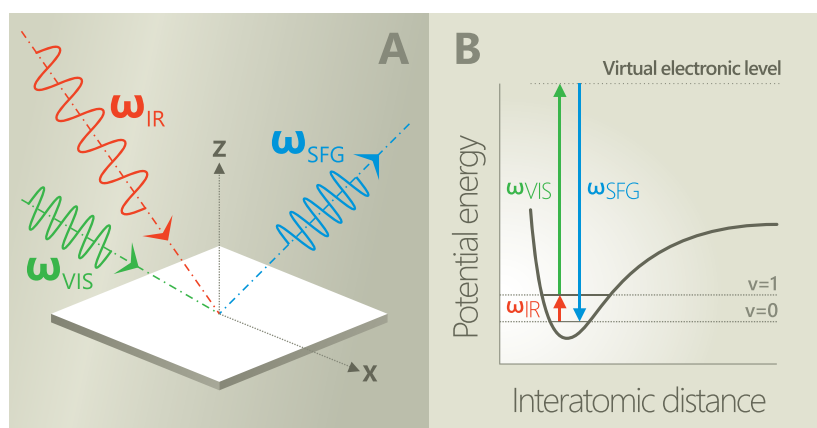

SFG signal generation diagram (a) and the molecular energy level diagram for the SFG process (b)

Picosecond Vibrational Sum Frequency Generation Spectrometer

ADVANTAGES

- ▶ Sensitive and selective to the orientation of molecules in the surface layer
- ▶ Intrinsically surface specific
- ▶ Selective to adsorbed species
- ▶ Sensitive to submonolayer of molecules
- ▶ Applicable to all interfaces accessible to light
- ▶ Nondestructive
- ▶ Capable of high spectral and spatial resolution

APPLICATIONS

- ▶ Investigation of surfaces and interfaces of solids, liquids, polymers, biological membranes and other systems
- ▶ Studies of surface structure, chemical composition and molecular orientation
- ▶ Remote sensing in hostile environment
- ▶ Investigation of surface reactions under real atmosphere, catalysis, surface dynamics
- ▶ Studies of epitaxial growth, electrochemistry, material and environmental problems

Narrowband picosecond scanning and broadband femtosecond SFG spectrometer

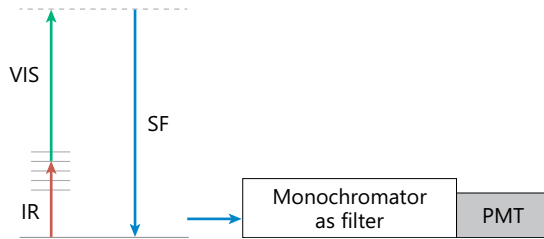

Narrowband picosecond scanning SFG spectrometer

In order to get SFG spectrum during measurement wavelength of narrowband mid-IR pulse is changed point-by-point throughout the range of interest. Narrowband SFG signal is recorded by the time-gated photomultiplier. Energy of each mid-IR, VIS and SFG pulse is measured. After the measurement, the SFG spectrum can be normalised according to IR and VIS energy. Spectral resolution is determined by the bandwidth of the mid-IR light source. The narrower mid-IR pulse bandwidth, the better the SFG spectral resolution. Separate vibrational modes are excited during the measurement.

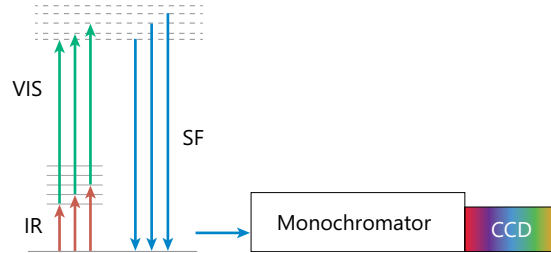

Broadband femtosecond SFG spectrometer

A broadband mid-IR pulse is mixed with a narrowband VIS pulse. The result is broadband SFG spectrum which is recorded using a monochromator and a sensitive CCD camera. The full spectrum is acquired simultaneously by integrating signal over time. Spectral resolution is determined by the bandwidth of the VIS pulse and on the monochromator-camera combination. The narrower the bandwidth of VIS pulse, the better the SFG spectral resolution.

COMPARISON OF DIFFERENT SFG SPECTROMETERS

Narrowband picosecond scanning spectrometer	Broadband femtosecond high resolution spectrometer
Narrowband mid-IR excitation, only one band is excited. Coupled states can be separated.	Simultaneous excitation and recording of broad vibration spectrum with high resolution.
High mid-IR pulse energy. Less influence of IR absorption in the air.	High mid-IR intensity at low pulse energy – suitable for biological or other water containing samples.
No reference spectrum needed, IR energy measured at each spectral point.	Optically coupled IR and VIS channels. Reduced complexity and increased stability of the system.

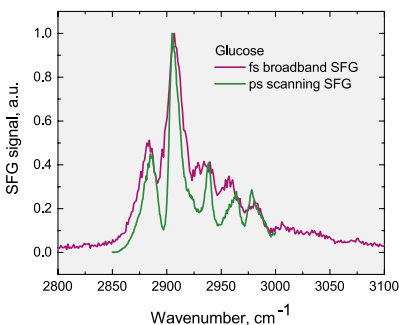

SFG spectra of glucose

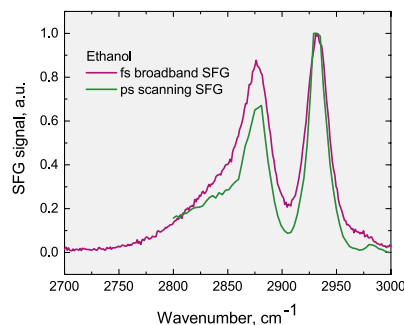

SFG spectra of ethanol

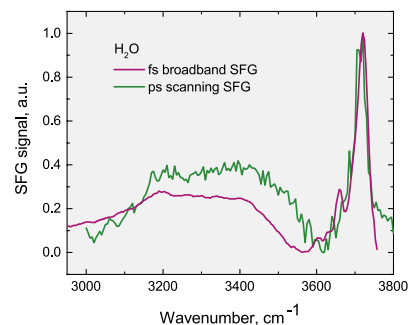

SFG spectra of water

Spectra are different because of different water samples. Water spectrum strongly depends on purity of the water.

Features and design of the picosecond scanning SFG spectrometer

The SFG spectrometer developed by Ekspla engineers is a nonlinear spectrometry instrument, convenient for everyday use. Ekspla manufactures SFG spectrometers, which are used by chemists, biologists, material scientists, and physicists. The spectrometer has many features that help to set up measurements and to make successful vibrational spectroscopy studies. For chemical and biochemical laboratories, this makes the Ekspla SFG spectrometer a reliable workhorse with a broad spectral region, automatically tuned from 1,000 to 4,300 cm^{-1} , a high spectral resolution (2 or 6 cm^{-1}), and easily controlled adjustment of polarisation optics.

The Ekspla SFG system is based on a mode-locked Nd:YAG laser with a 29 ps pulse duration, with 30 – 40 mJ pulse energy at 1,064 nm and a 50 Hz repetition rate. The VIS channel of the SFG spectrometer consists of part of a laser output beam, usually with doubled frequency (532 nm) up to 0.5 mJ. The main part of the laser radiation goes to an optical parametric generator (OPG) with a difference frequency generation (DFG) extension. The IR channel of the spectrometer is pumped by the DFG output beam with energy in the range of $\sim 40 - 200 \mu\text{J}$. Infrared light

can be tuned in a very broad spectral range from 2.3 up to 10 (optionally up to 16) μm . The bandwidth is 2 or 6 cm^{-1} (depending on the selected OPG model) and it is one of the main factors of SFG spectrometer spectral resolution. The second beam (VIS) is also narrowband at $< 2 \text{ cm}^{-1}$. The spectrometer detection system has a temporal gate. It reduces noise collection and ambient light influence, which allows the spectrometer to be used even in a brightly illuminated room. The spectrometer does not have any acoustic noise because the laser is pumped by diodes. The spot size of the IR beam is adjustable. In this way, the appropriate energy density is achieved to avoid damaging the sample. Spectrum scanning, polarisation control and VIS beam attenuation are controlled from a computer. The spectrometer has a motorized polarisation switch for the IR, optionally for the VIS, and optionally the generated SFG light beams. Special detectors continuously monitor the energy of the VIS and mid-IR laser pulses, so IR energy is checked at each measurement point. This makes it easy to normalize the resulting SFG vibrational spectrum.

SYSTEM COMPONENTS

- ▶ Picosecond mode-locked Nd:YAG laser
- ▶ Multichannel beam delivery unit
- ▶ Picosecond optical parametric generator
- ▶ Spectroscopy module
- ▶ Monochromator
- ▶ PMT based signal detectors
- ▶ Data acquisition system
- ▶ Dedicated LabView® software package for system control

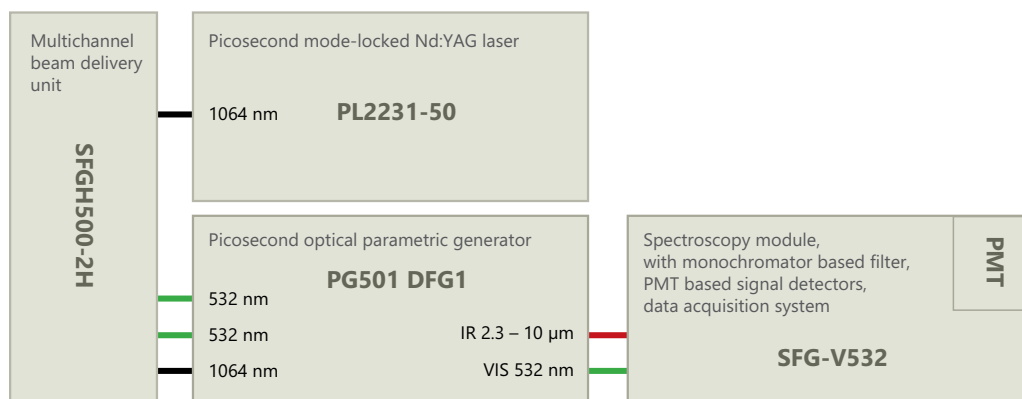

Schematic layout of SFG Classic spectrometer

SPECTROSCOPY MODULE, SAMPLE COMPARTMENT

A large sample compartment can be customised and enables the use of various extensions and additional instruments for simultaneous control of the sample conditions, including a Langmuir-Blodgett trough for air/water and lipid/air interface studies, temperature and humidity-controlled cells, and other instruments.

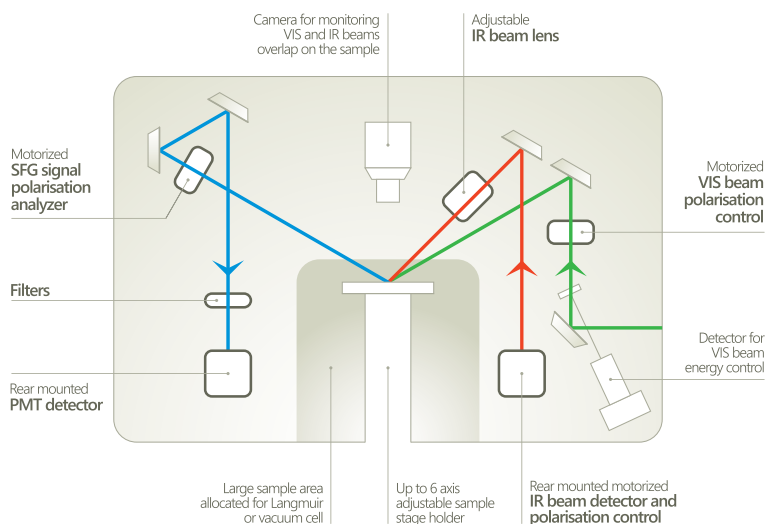

Standard layout of the vertically-arranged sample compartment of the SFG spectrometer

SAFETY OF THE SFG SPECTROMETER

The spectrometer is safe to use: all high energy pulsed beams are enclosed. In addition, the sample area also has a special cover. During the measurements, it is possible to close the sample compartment so that radiation cannot penetrate outside. The automatic change of polarisation

and energy attenuation makes it possible to perform measurements without opening the spectrometer. Laser safety precautions are required only for the alignment of the laser beams on the studied surface.

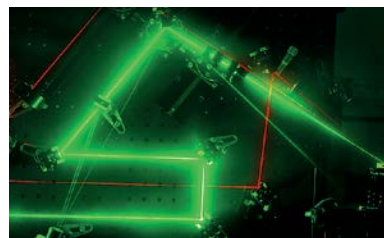

SPECTRA EXAMPLES

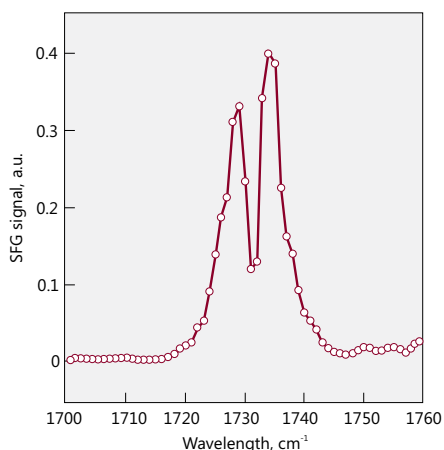

SFG spectra of monoolein surface, 1 cm⁻¹ scan step, 200 acquisitions per step

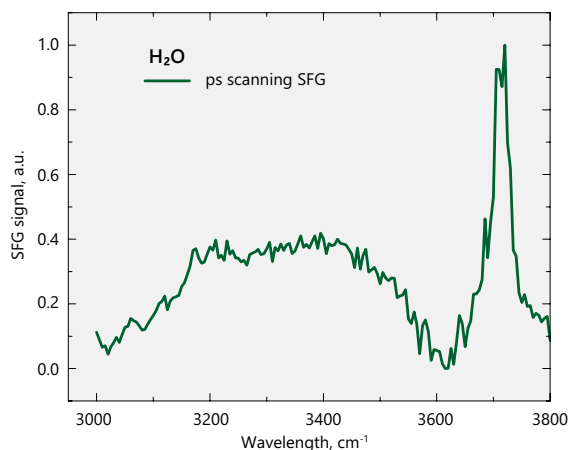

Water-air interface spectra, 200 acquisitions per step

Technical specifications ¹⁾ of picosecond scanning SFG spectrometer

Version	SFG Classic	SFG Advanced	SFG Double resonance	SFG Phase sensitive
SYSTEM (GENERAL)				
Spectral range	1000 – 4300 cm ⁻¹	625 – 4300 cm ⁻¹	1000 – 4300 cm ⁻¹	1000 – 4300 cm ⁻¹
Spectral resolution	<6 cm ⁻¹ (optional <2 cm ⁻¹)	<6 cm ⁻¹ (optional <2 cm ⁻¹)	<10 cm ⁻¹	<6 cm ⁻¹ (optional <2 cm ⁻¹)
Spectra acquisition method	Scanning			
Sample illumination geometry	Top side, reflection (optional: bottom side, top-bottom side)			
Incidence beams geometry	Co-propagating, non-collinear			
Incidence angles	Fixed, VIS ~60°, IR ~55° (optional: tunable)			Fixed, VIS ~60°, IR ~55°
VIS beam wavelength	532 nm (optional: 1064 nm)	532 nm (optional: 1064 nm)	532 nm and tunable 420 – 680 nm	532 nm
Polarization (VIS, IR, SFG)	Linear, selectable "s" or "p", purity > 1:100			
IR Beam spot on the sample	Selectable, ~150 – 600 μm			Fixed
Sensitivity	Air-water spectra			Solid sample
PUMP LASERS ²⁾				
Model	PL2231-50	PL2231-50	PL2231A	PL2231-50
Pulse energy	Optimised to pump PG			
Pulse duration	29 ± 5 ps			
Pulse repetition rate	50 Hz			
OPTICAL PARAMETRIC GENERATORS				
IR source with standard linewidth (<6 cm ⁻¹)	PG501-DFG1	PG501-DFG2	PG501-DFG1	
IR source with narrow linewidth (<2 cm ⁻¹)	PG511-DFG	PG511-DFG2	inquire	PG511-DFG
UV-VIS source for Double resonance SFG	–		PG401	–
<i>For standard specifications please check the brochure of particular model.</i>				
PHYSICAL DIMENSIONS (FOOTPRINT)				
Standard	2700 × 1200 mm		3000 × 1500 mm	2700 × 1200 mm
Extended (with special options or large accessories)	2800 × 1200 mm		3000 × 1500 mm	2700 × 1200 mm

¹⁾ Due to continuous improvement, all specifications are subject to change without advance notice.

²⁾ Laser is optimised for pumping parametrical generator, maximum output energy may be different than specified for stand alone application.

Features and design of the broadband femtosecond SFG spectrometer

Femtosecond broadband SFG (BB SFG) spectrometer allows fast SFG spectra acquisition since most vibrational modes can be resolved without scanning. The advantage of the broadband SFG system is that intense femtosecond pulses allow efficient sum frequency generation at low pulse energies thus reducing the possibility of sample modification. It is especially important for aqueous and biological samples.

The system is based on a femtosecond industrial FemtoLux® series laser with 500 fs pulse duration, more than 1 mJ pulse energy at 1030 nm and a 1 kHz repetition rate. The main part of the laser radiation is directed to a broadband mid-IR OPA module. Broad bandwidth ($150 - 450 \text{ cm}^{-1}$) mid-IR radiation can be continuously tuned in a spectral range from 2.5 up to 10 μm , providing from 0.5 to 12 μJ energy transform-limited pulses for the IR channel. The VIS channel realisation depends on

the system configuration. In standard setup, a part of laser output radiation is frequency doubled (515 nm) $\sim 20 \mu\text{J}$ and then spectrally filtered to produce $< 8 \text{ cm}^{-1}$ bandwidth pulses. High resolution version consists of optically synchronised femtosecond and picosecond lasers. The combination of broadband mid-IR and narrowband VIS radiation allows to get the broadband sum frequency signal with exceptionally high spectral resolution close to 3 cm^{-1} .

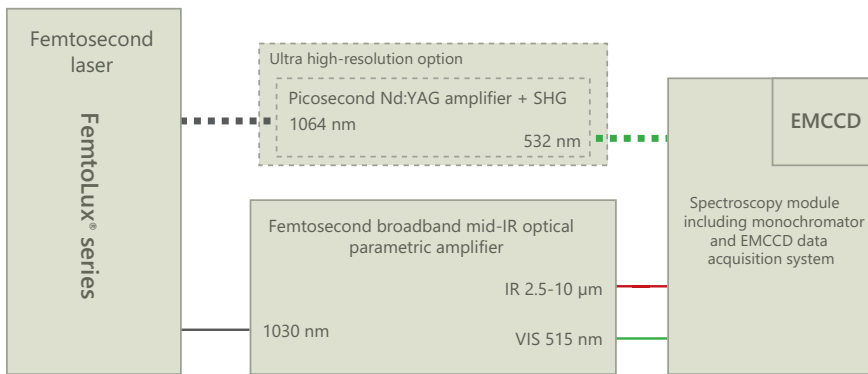

Schematic layout of BB SFG spectrometer

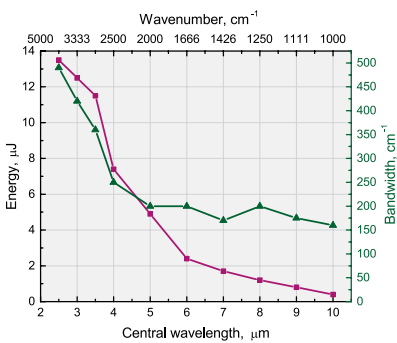

Mid-IR parametrical amplifier characteristics. Energy and spectral bandwidth versus central wavelength

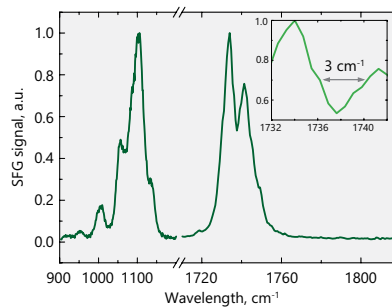

Spectral resolution of 3 cm^{-1} demonstrated by measuring monoolein SFG spectrum

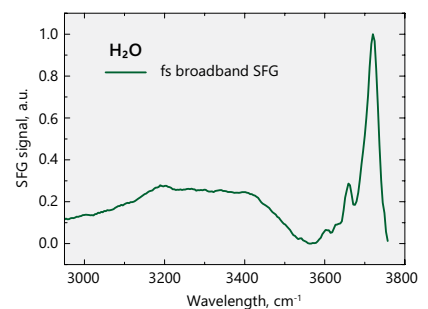

Pure water spectrum. Spectrum acquisition time 10 min

Technical specifications ¹⁾ of broadband femtosecond SFG spectrometer

Version	SFG fs	SFG fs high resolution
SYSTEM (general)		
Spectral range	1000 – 4300 cm ⁻¹	1000 – 4300 cm ⁻¹
Spectral resolution	< 8 cm ⁻¹	< 3 cm ⁻¹
Spectral bandwidth	150 – 450 cm ⁻¹	
Spectra acquisition method	Broadband accumulative	
Sample illumination geometry	Top side, reflection (optional: bottom side, top-bottom side, total internal reflection)	
Incidence beams geometry	Co-propagating, non-colinear (optional: colinear)	
Incidence angles	Fixed, VIS ~60°, IR ~55° (optional: tunable)	
VIS beam wavelength	515 nm	532 nm
Polarization (VIS, IR, SFG)	Linear, selectable "s" or "p", purity > 1:100	
Beam spot on the sample	Adjustable, ~150 – 600 μm	
Sensitivity	Air-water spectra	
PHYSICAL DIMENSIONS (footprint)		
Standard	2000 × 1500 mm	2200 × 1500 mm

¹⁾ Due to continuous improvement, all specifications are subject to change without advance notice.

Ordering Information

Delivery	Products are made and dispatched within agreed term. Shipping charges are object of agreement between EKSPLA and customer.
Ordering	Orders may be placed by mail, fax or e-mail. All orders are object of General Sales Conditions, which can be found on www.ekspla.com . Mail orders should be sent to: EKSPLA, UAB Savanoriu Av. 237 LT-02300 Vilnius Lithuania Phone: +370 5 264 96 29 Fax: +370 5 264 18 09 E-mail: sales@ekspla.com Ask for quotation online at www.ekspla.com.
Certificate of Origin	All items shown in this catalogue are of Lithuanian Origin (EU). Certificate of Origin is available under request.
Warranty	All products are guaranteed to be free from defects in material and workmanship. The warranty period depends on the product and is object of agreement between EKSPLA and customer. Warranty period can be extended by separate agreement. EKSPLA does not assume liability for unproper installation, labour or consequential damages.
Specifications	Due to the constant product improvements, EKSPLA reserves its right to change specifications without advance notice.

For latest information visit www.ekspla.com.

Notes

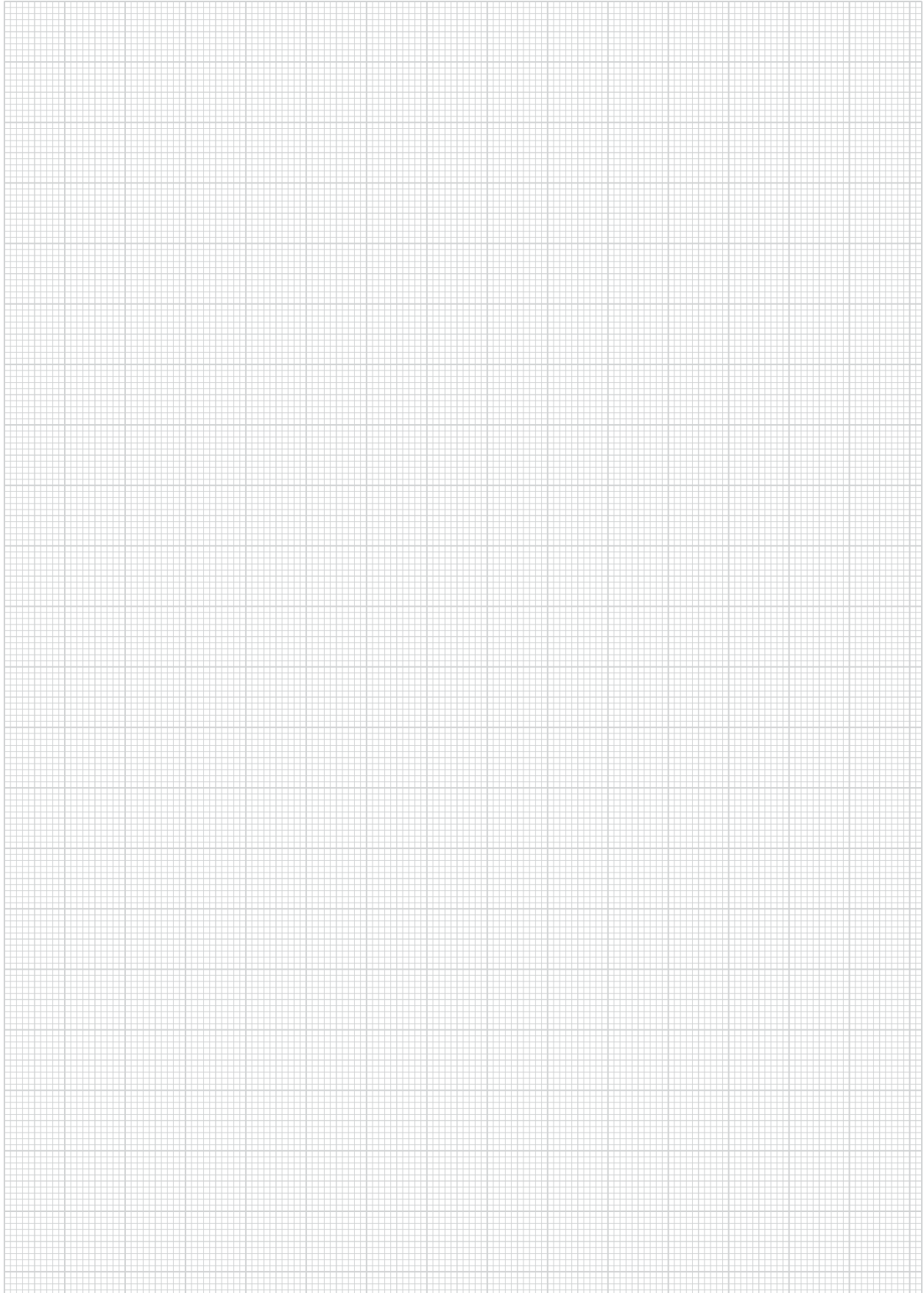



ISO9001 Certified

Find local distributor at
www.ekspla.com



Follow us on Linked 

Savanorių Av. 237
LT-02300 Vilnius
Lithuania

ph. +370 5 264 96 29
fax +370 5 264 18 09
sales@ekspla.com
www.ekspla.com